

HC100™

Wristband Printer

User Guide



© 2012 ZIH Corp. The copyrights in this manual and the software and/or firmware in the printer described therein are owned by ZIH Corp. and Zebra's licensors. Unauthorized reproduction of this manual or the software and/or firmware in the printer may result in imprisonment of up to one year and fines of up to \$10,000 (17 U.S.C.506). Copyright violators may be subject to civil liability.

This product may contain ZPL[®], ZPL II[®], and ZebraLink[™] programs; Element Energy Equalizer[®] Circuit; E³[®]; and Monotype Imaging fonts. Software © ZIH Corp. All rights reserved worldwide.

ZebraLink and all product names and numbers are trademarks, and Zebra, the Zebra logo, ZPL, ZPL II, Element Energy Equalizer Circuit, and E³ Circuit are registered trademarks of ZIH Corp. All rights reserved worldwide.

All other brand names, product names, or trademarks belong to their respective holders. For additional trademark information, please see "Trademarks" on the product CD.

Proprietary Statement This manual contains proprietary information of Zebra Technologies Corporation and its subsidiaries. It is intended solely for the information and use of parties operating and maintaining the equipment described herein. Such proprietary information may not be used, reproduced, or disclosed to any other parties for any other purpose without the express, written permission of Zebra Technologies Corporation.

Product Improvements Continuous improvement of products is a policy of Zebra Technologies Corporation. All specifications and designs are subject to change without notice.

Liability Disclaimer Zebra Technologies Corporation takes steps to ensure that its published Engineering specifications and manuals are correct; however, errors do occur. Zebra Technologies Corporation reserves the right to correct any such errors and disclaims liability resulting therefrom.

Limitation of Liability In no event shall Zebra Technologies Corporation or anyone else involved in the creation, production, or delivery of the accompanying product (including hardware and software) be liable for any damages whatsoever (including, without limitation, consequential damages including loss of business profits, business interruption, or loss of business information) arising out of the use of, the results of use of, or inability to use such product, even if Zebra Technologies Corporation has been advised of the possibility of such damages. Some jurisdictions do not allow the exclusion or limitation of incidental or consequential damages, so the above limitation or exclusion may not apply to you.



Declaration of Conformity

We have determined that the Zebra printers identified as the

HC100™

manufactured by:

Zebra Technologies Corporation
333 Corporate Woods Parkway
Vernon Hills, Illinois 60061-3109 U.S.A.

Have been shown to comply with the applicable technical standards of the FCC

For Home, Office, Commercial, and Industrial use

If no unauthorized change is made in the equipment,
and if the equipment is properly maintained and operated.

FCC Compliance Statement

This device complies with Part 15 rules. Operation is subject to the following two conditions:

1. This device may not cause harmful interference, and
2. This device must accept any interference received, including interference that may cause undesired operation.

The user is cautioned that any changes or modifications not expressly approved by Zebra Technologies Corporation could void the user's authority to operate the equipment. To ensure compliance, this printer must be used with Shielded Communication Cables.

FCC Radiation Exposure Statement (for printers with internal radio devices)

This equipment complies with FCC radiation exposure limits set forth for an uncontrolled environment. This equipment should be installed and operated with minimum distance 20cm between the radiator and your body.

This transmitter must not be co-located or operating in conjunction with any other antenna or transmitter.

FCC Rules and Regulations for Data Cables

Zebra printers comply with FCC Rules and Regulations, Part 15 for Class B Equipment using fully shielded, 6.5 ft. (2 m) data cables. Use of unshielded cables may increase radiation above the Class B limits.

Canadian DOC Compliance Statement

This Class B digital apparatus complies with Canadian ICES-003.

Cet appareil numérique de la classe B est conforme à la norme NMB-003 du Canada.

About This Document



This section provides you with contact information, document structure and organization, and additional reference documents.

Contents

Who Should Use This Document	vi
How This Document Is Organized	vi
Contacts	vii
Document Conventions	viii

Who Should Use This Document

This User Guide is intended for use by any person who needs to operate or to troubleshoot the printer. An additional section is included for advanced users or service technicians.

How This Document Is Organized

The User Guide is set up as follows:

Section	Description
<i>Introduction to the HC100 on page 1</i>	This section shows the printer components, indicator lights, and operational controls.
<i>Printer Setup on page 11</i>	This section provides instructions for setting up the printer, connecting it to your network, and preparing it for use.
<i>Troubleshooting on page 19</i>	This section includes the meaning of various printer status lights.
<i>Routine Maintenance on page 29</i>	This section includes routine cleaning procedures and recycling information.
<i>Advanced User Information on page 41</i>	This section contains information and instructions that are intended only for advanced users or service technicians.
<i>Specifications on page 61</i>	This section contains the specifications for the printer and wristbands.

Contacts

Technical Support via the Internet is available 24 hours per day, 365 days per year.

Web Site: www.zebra.com

E-mail Back Technical Library:

E-mail address: emb@zebra.com

Subject line: Emaillist

Self Service Knowledge Base: www.zebra.com/knowledgebase

Online Case Registration: www.zebra.com/techrequest

Which Department Do You Need?	The Americas	Europe, Middle East, and Africa	Asia Pacific and India
Regional Headquarters	Zebra Technologies Corporation 475 Half Day Road, Suite 500 Lincolnshire, IL 60069 USA T: +1 847 634 6700 Toll-free +1 866 230 9494 F: +1 847 913 8766	Zebra Technologies Europe Limited Dukes Meadow Millboard Road Bourne End Buckinghamshire, SL8 5XF United Kingdom T: +44 (0) 1628 556000 F: +44 (0) 1628 556001	Zebra Technologies Asia Pacific Pte. Ltd. 120 Robinson Road #06-01 Parakou Building Singapore 068913 T: + 65 6858 0722 F: +65 6885 0838
Technical Support For questions on the operation of Zebra equipment and software, please call your distributor. For additional assistance, contact us. Please have your model and serial numbers available.	T: +1 877 ASK ZEBRA (275 9327) F: +1 847 913 2578 Hardware: ts1@zebra.com Software: ts3@zebra.com <i>Kiosk printers:</i> T: +1 866 322 5202 E: kiosksupport@zebra.com	T: +44 (0) 1628 556039 F: +44 (0) 1628 556003 E: Tseurope@zebra.com	T: +65 6858 0722 F: +65 6885 0838 E: <i>China:</i> tschina@zebra.com <i>All other areas:</i> tsasiapacific@zebra.com
Repair Service Department For back-to-base service and repair.	T: +1 877 ASK ZEBRA (275 9327) F: +1 847 821 1797 E: repair@zebra.com To request a repair in the U.S., go to www.zebra.com/repair .	T: +44 (0) 1772 693069 F: +44 (0) 1772 693046 New requests: ukrma@zebra.com Status updates: repairupdate@zebra.com	T: +65 6858 0722 F: +65 6885 0838 E: <i>China:</i> tschina@zebra.com <i>All other areas:</i> tsasiapacific@zebra.com
Technical Training Department For Zebra product training courses.	T: +1 847 793 6868 T: +1 847 793 6864 F: +1 847 913 2578 E: ttamerica@zebra.com	T: +44 (0) 1628 556000 F: +44 (0) 1628 556001 E: Eurtraining@zebra.com	T: + 65 6858 0722 F: +65 6885 0838 E: <i>China:</i> tschina@zebra.com <i>All other areas:</i> tsasiapacific@zebra.com
Inquiry Department For product literature and distributor and dealer information.	T: +1 877 ASK ZEBRA (275 9327) E: inquiry4@zebra.com	T: +44 (0) 1628 556037 F: +44 (0) 1628 556005 E: mseurope@zebra.com	E: <i>China:</i> GCmarketing@zebra.com <i>All other areas:</i> APACChannelmarketing@zebra.com
Customer Service Department (US) Internal Sales Department (UK) For printers, parts, media, and ribbon, please call your distributor or contact us.	T: +1 877 ASK ZEBRA (275 9327) E: clientcare@zebra.com	T: +44 (0) 1628 556032 F: +44 (0) 1628 556001 E: cseurope@zebra.com	T: +65 6858 0722 F: +65 6885 0836 E: <i>China:</i> order-csr@zebra.com <i>All other areas:</i> csasiapacific@zebra.com

Key: T: Telephone
 F: Facsimile
 E: E-mail

Document Conventions

The following conventions are used throughout this document to convey certain information.

Alternate Color (online only) Cross-references contain hot links to other sections in this guide. If you are viewing this guide online in .pdf format, you can click the cross-reference ([blue text](#)) to jump directly to its location.

Icons Used



Caution • Warns you of the potential for electrostatic discharge.



Caution • Warns you of a situation where excessive heat could cause a burn.



Caution • Advises you that failure to take or avoid a specific action could result in physical harm to you.

Caution • (No icon) Advises you that failure to take or avoid a specific action could result in physical harm to the hardware.



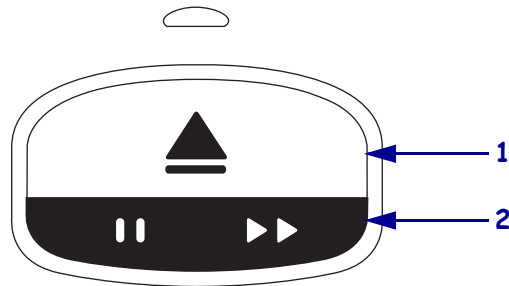
Important • Advises you of information that is essential to complete a task.



Note • Indicates neutral or positive information that emphasizes or supplements important points of the main text.




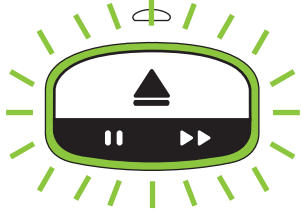







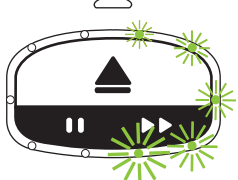


Illustration Callouts Callouts are used when an illustration contains information that needs to be labeled and described. A table that contains the labels and descriptions follows the graphic. [Figure 1](#) provides an example.

Figure 1 • Sample Figure with Callouts



1	Eject button
2	Pause/Feed button

Control Panel Lights The printer status indicator uses green, yellow, and orange lights that sometimes blink or rotate to indicate the printer’s status and any error conditions. The lights and light sequences are indicated as follows:

<p>Lights On</p> 	<p>A solid, colored bar indicates when the printer status indicator is on.</p>  <p>A solid bar that is divided into two colors indicates that half of the printer status indicator lights are on with one color while the other half of the lights are on with the other color.</p> 
<p>Lights Flashing or Blinking</p> 	<p>Alternating colors in a subdivided bar indicate that the lights on the printer status indicator are flashing or blinking.</p> <ul style="list-style-type: none"> • one colored blink • two colored blinks • steady color on with two blinks off • three colored blinks • four colored blinks • consistent flashing on and off • flashing between two colors.       
<p>Lights Rotating</p> 	<p>The printer status indicator lights can light up in a clockwise rotating sequence.</p> <p>Rotating lights that come on one at a time are indicated by a curved, broken arrow and a bar that shows the color of the lights.</p>  <p>Rotating lights that stay on after lighting up are indicated by a curved, solid arrow and a bar that shows the color of the lights.</p> 

Contents



Declaration of Conformity	iii
FCC Compliance Statement	iv
FCC Radiation Exposure Statement (for printers with internal radio devices)	iv
FCC Rules and Regulations for Data Cables	iv
Canadian DOC Compliance Statement	iv
About This Document	v
Who Should Use This Document	vi
How This Document Is Organized	vi
Contacts	vii
Document Conventions	viii
1 • Introduction to the HC100	1
Front of Printer	2
Rear of Printer and Connectors	3
Control Panel	4
Control Panel Lights	4
Control Panel Buttons	4
Media Cartridges and Wristbands	6
Media Cartridges	6
Wristband Sizes	7
Wristband Colors	7
Wristband Closure Type	8
Wristband Print Zone	10

2 • Printer Setup	11
Handling the Printer	12
Unpack and Inspect the Printer	12
Store the Printer	12
Ship the Printer	12
Preparing the Printer for Use	13
Site Selection	13
Connect to Data Communication Interfaces	13
Connect to Power Source and Turn on Power	15
Insert Media Cartridge	17
3 • Troubleshooting	19
Media Status Indicator	20
Printer Status Indicator	22
Wireless Status Indicator	25
Miscellaneous Troubleshooting	26
4 • Routine Maintenance	29
Cleaning the Media Path	30
Using a Cleaning Card	30
Using a Swab	32
Cleaning the Smart Card Contacts and the Media Cartridge Sensor Pins	38
Replacing Printer Components	40
Ordering Replacement Parts	40
Recycling Printer Components	40
Lubrication	40
5 • Advanced User Information	41
Viewing Printer Settings	42
On a Printer Configuration Wristband	42
Through the Printer's Web Pages	43
Changing and Restoring Printer Settings	44
Setting, Changing, and Restoring Print Server Settings	52
Connecting for the First Time	52
Changing Parameters after Connecting	52
Web Pages	56
Additional Diagnostics Tools	58
Media Sensor Profile	58
Communications Diagnostics Test	59
Downloading Firmware	60
6 • Specifications	61
Physical and Environmental	62

Printing	62
Standard and Optional Features	62
Power Cord	63



Introduction to the HC100

This section shows the printer components, indicator lights, and operational controls.

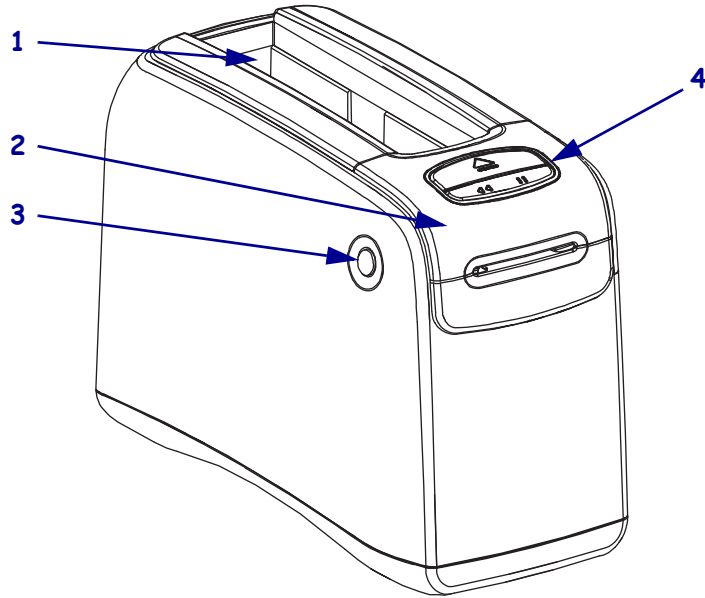
Contents

Front of Printer	2
Rear of Printer and Connectors	3
Control Panel	4
Control Panel Lights	4
Control Panel Buttons	4
Media Cartridges and Wristbands	6
Media Cartridges	6
Wristband Sizes	7
Wristband Colors	7
Wristband Closure Type	8
Wristband Print Zone	10

Front of Printer

Figure 1 shows the front of the printer.

Figure 1 • Front of Printer

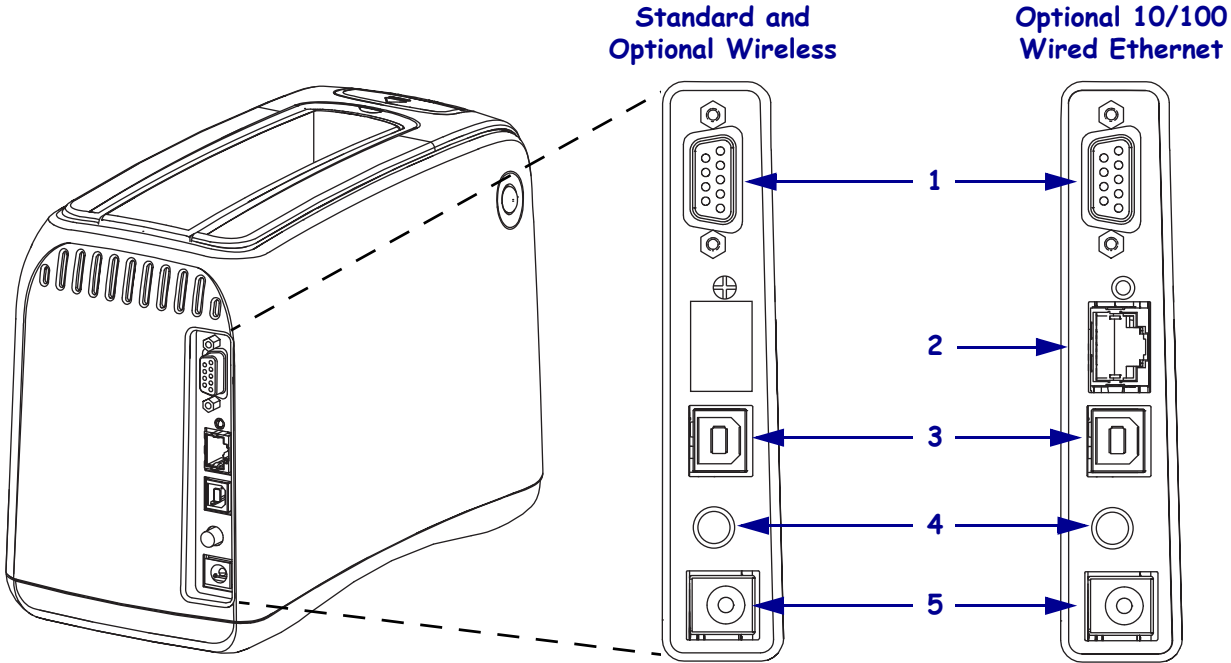







1	Media cartridge slot
2	Upper cover
3	Upper cover release button (one on each side)
4	Control panel (see <i>Control Panel</i> on page 4)

Rear of Printer and Connectors

Figure 2 shows the data communication connectors on the rear of the printer, the power button, and the D/C power connector. For more information about the optional wired and wireless Ethernet print servers, see [Connect to Data Communication Interfaces on page 13](#) and [Changing and Restoring Printer Settings on page 44](#).

Figure 2 • Rear of Printer



1		Serial port
2		Optional ZebraNet® 10/100 Internal Print Server (wired Ethernet) port
3		USB port
4		Power on/off button (in is On, out is Off)
5		D/C power connector

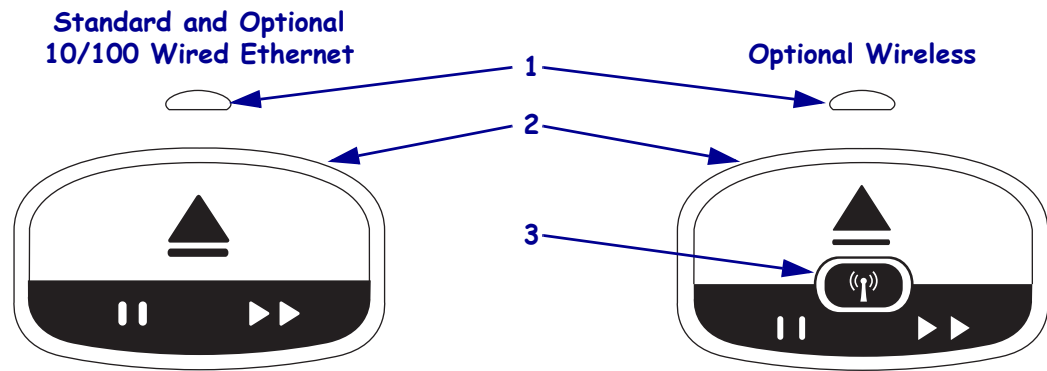
Control Panel

The control panel is located on the front of the printer.

Control Panel Lights

The control panel has two basic lights that indicate the printer's status and error conditions (Figure 3). Printers with the Wireless Ethernet Option have an additional status indicator light.

Figure 3 • Control Panel Lights

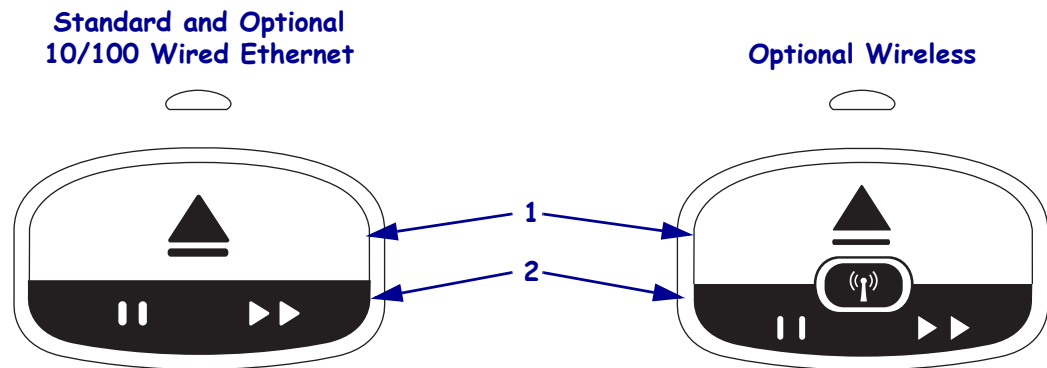


1	Media status indicator (see Media Status Indicator on page 20)
2	Printer status indicator (outer ring) (see Printer Status Indicator on page 22)
3	Wireless status indicator (see Wireless Status Indicator on page 25)

Control Panel Buttons


The control panel has two buttons (Figure 4). Their function is described in Table 1. When you press or press and hold a button, the printer action occurs when you release the button.

Figure 4 • Control Panel Buttons



1	EJECT button
2	PAUSE/FEED button

Table 1 • Function of the Control Panel Buttons

Button	Function/Description
EJECT	<p>This button functions only when the printer is idle or paused. The function depends on whether you press the button or press and hold it.</p> <ul style="list-style-type: none"> • Pressing and releasing EJECT causes the printer to retract the current wristband and eject the media cartridge. • Pressing and holding EJECT for 6 seconds force ejects the media cartridge without retracting the protruding wristband. After a forced eject, press the upper cover release buttons to open the printer's upper cover and release the wristband. See Media Cartridges on page 6 for information on removing the wristband from the cartridge. Do NOT pull the remainder of the wristband out of the cartridge. <p> Note • If pressing EJECT does not eject the media cartridge, power cycle the printer and press EJECT again. Use the forced eject option only as a last resort if these other attempts fail.</p>
PAUSE/FEED	<p>PAUSE/FEED has different functions depending on whether the printer is idle or paused and on whether you press the button or press and hold it.</p> <ul style="list-style-type: none"> • Pressing and releasing PAUSE/FEED has two functions. <ul style="list-style-type: none"> • Pause—PAUSE/FEED functions as a pause button when the printer is actively printing a wristband. While a wristband is printing, press the button to pause the printer before the next wristband starts printing. The printer remains paused until you press the button again. • Feed—PAUSE/FEED functions as a feed button when the printer is idle. Press the button to feed one blank wristband. • Pressing and holding PAUSE/FEED places the printer in user configuration mode. The printer status indicator lights blink orange in 2-second intervals, adding one blink each interval. Depending on when you release PAUSE/FEED, different actions take place: <ul style="list-style-type: none"> • One orange blink—A printer configuration wristband prints. • Two orange blinks—A media sensor profile prints. • Three orange blinks—The printer resets all print server parameters (wired Ethernet and wireless Ethernet) back to defaults. This is equivalent to sending the ^JUN ZPL II command. • Four orange blinks—The printer resets all printer parameters back to defaults. This is equivalent to sending the ^JUF ZPL II command. • After four orange blinks, the printer exits user configuration mode. The printer status lights return to solid green. The printer feeds a wristband when you release PAUSE/FEED.

Media Cartridges and Wristbands

Zebra’s HC100 printer is developed to maximize ease of use. There’s minimal training required. Just pop the easy-to-load cartridges containing Zebra’s Z-Band® wristbands into the printer—and print individual wristbands. The HC100 printer detects the wristband size and automatically calibrates its settings for optimal print quality. You get long-lasting wristbands with bar codes and text that remain readable.

Different sizes, colors, and closure types of wristbands are available in recyclable media cartridges. This information appears on the media cartridge label.

See the Zebra Web site (www.zebra.com) for the latest information on media types for various uses and environments including antimicrobial coated wristbands.

For ordering information, see *Contacts* on page vii. Only Genuine Zebra™ supplies will work with your printer.

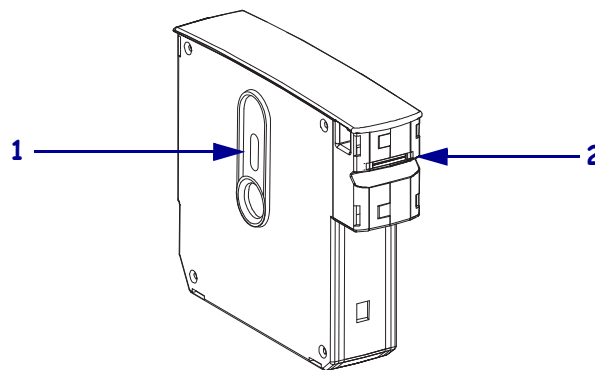


Media cartridges cannot be reused or refilled. Dispose of media cartridges in accordance with your local regulations or standards. For information on Zebra's recycling program, see <http://www.zebra.com/environment>.

Media Cartridges

View the level of media remaining in the cartridge through the wristband supply window on the left side of the media cartridge (Figure 5). Wristbands exit through a slot on the front of the media cartridge.

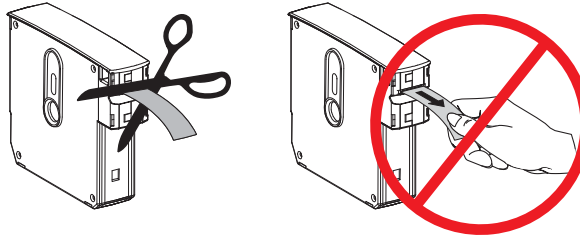
Figure 5 • Media Cartridge



1	Wristband supply window
2	Wristband exit area



Important • Forcibly pulling a wristband from the media cartridge can damage the cartridge. A damaged cartridge will not work. If a wristband sticks out partially from a cartridge, use scissors to cut off the exposed part so that it is flush with the cartridge. Do NOT pull the remainder of the wristband out of the cartridge. The printer will eject the partial wristband after the cartridge loads properly.



Wristband Sizes

The size of the wristbands is indicated on the top of each media cartridge (Figure 6). A wristband should be snug enough to stay on the person's wrist or ankle but not so tight that it cuts into the person's skin or cuts off circulation.

Figure 6 • Wristband Size Indicators



Adult



Pediatric



Infant

Wristband Colors

Wristbands are available in seven colors for color-coding.

Adhesive Closure Type

- Red
- Blue
- Yellow
- Green
- Pink
- Purple
- Orange
- White

Clip Closure Type

- Red
- Blue
- Yellow
- Green
- Pink
- Purple
- White

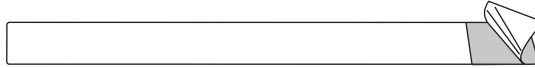
Wristband Closure Type

Zebra offers two types of wristband: adhesive closure and clip closure.

Adhesive Wristbands

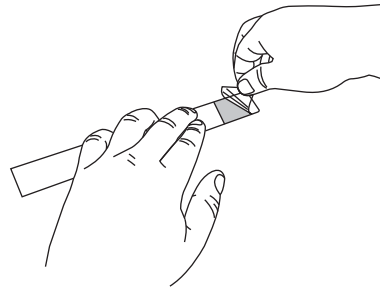
Zebra Z-Band™ Direct Wristbands are fastened with adhesives that are part of the wristband.

Figure 7 • Adhesive Closure Wristband



To fasten an adhesive wristband, complete these steps:

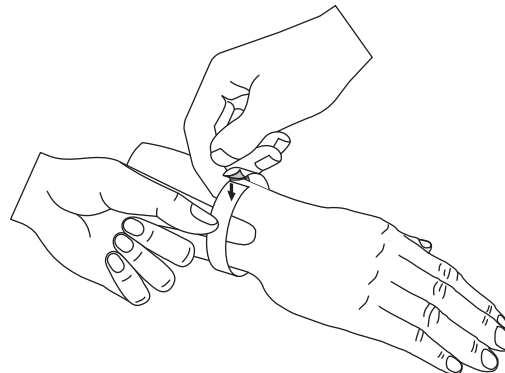
1. Remove the cover from the adhesive.



2. Wrap the wristband around a person's wrist or ankle, and then press the exposed adhesive to the wristband.



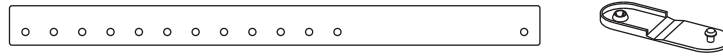
Important • To keep the wristband from being too loose or too tight, place your finger between the wristband and the person's wrist or ankle while fastening the wristband. Do not attempt to adjust the wristband after it is fastened. The tamper-evident slits under the adhesive tear if you try to remove the wristband.



Clip Wristbands

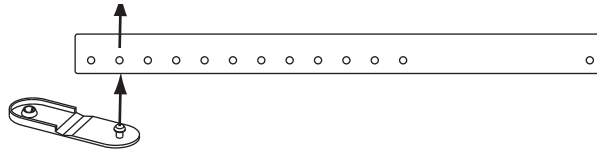
Zebra Z-Band™ QuickClip Wristbands are fastened with clips.

Figure 8 • Clip Closure Wristband

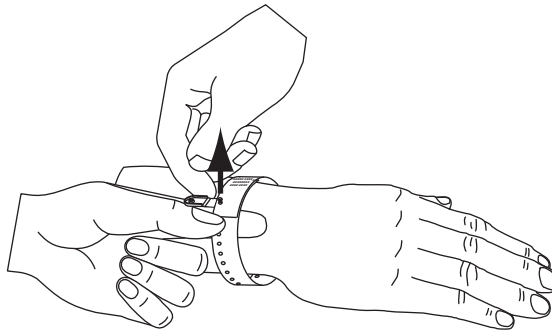


To fasten a clip wristband, complete these steps:

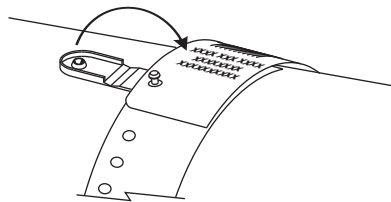
1. Insert the post on a clip through a hole on the wristband.



2. Wrap the wristband around a person's wrist or ankle, and then thread the post through the lone hole on the opposite end of the wristband. If necessary, move the clip to a different hole to resize the wristband.



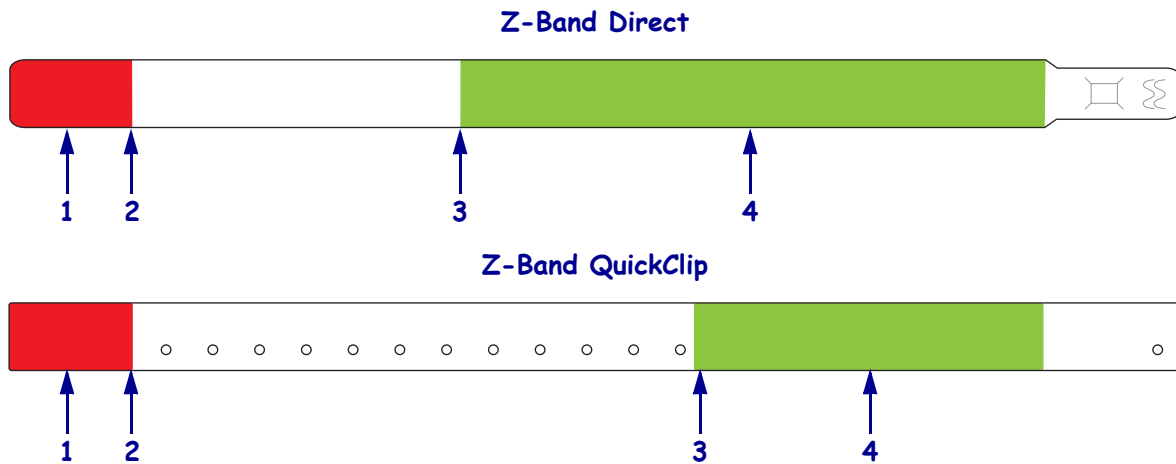
3. Fold the clip over, and press to lock it.



Wristband Print Zone

The best area for printing varies by wristband type. For best results, design your wristband formats so that they print in the recommended print zone of the wristband (Figure 9). Avoid printing over the clip holes (Z-Band QuickClip) or the tamper-evident slits (Z-Band Direct).

Figure 9 • Media Home Position and Recommended Print Zone



1	Non-printable area (shown in red)	You cannot print on approximately the first 1 inch (25.4 mm) of each wristband because the media does not backfeed into the printer.
2	Media home position	The media home position (0,0) occurs 1 in. (25.4 mm) from the leading edge of the wristband.
3	Recommended print start position	The start position from the leading edge of the wristband varies by wristband type (see Table 2).
4	Recommended print zone (shown in green)	This area is recommended for printing because it is visible on the patient after the wristband is secured.

Table 2 • Recommended Print Start Position by Label Type

Wristband Type	Wristband Length	Start Position from the Leading Edge
Z-Band Direct	11 in. (279 mm)	4.5 in. (114 mm)
	7 in. (178 mm)	2.5 in. (64 mm)
	6 in. (152 mm)	2 in. (51 mm)
Z-Band QuickClip	11 in. (279 mm)	6.25 in. (159 mm)
	7 in. (178 mm)	3.25 in. (83 mm)



Printer Setup

This section provides instructions for setting up the printer, connecting it to your network, and preparing it for use.

Contents

Handling the Printer	12
Unpack and Inspect the Printer	12
Store the Printer	12
Ship the Printer	12
Preparing the Printer for Use	13
Site Selection	13
Connect to Data Communication Interfaces	13
Connect to Power Source and Turn on Power	15
Insert Media Cartridge	17

Handling the Printer

This section describes how to handle your printer.

Unpack and Inspect the Printer

When you receive the printer, immediately unpack it and inspect for shipping damage.

- Save all packing materials.
- Check all exterior surfaces for damage.

If you discover shipping damage upon inspection:

- Immediately notify the shipping company and file a damage report.
- Keep all packaging material for shipping company inspection.
- Notify your authorized Zebra reseller



Important • Zebra Technologies Corporation is not responsible for any damage incurred during the shipment of the equipment and will not repair this damage under warranty.

Store the Printer

If you are not placing the printer into immediate operation, repackage it using the original packing materials. You may store the printer under the conditions shown in [Table 3](#).

Table 3 • Storage Temperature and Humidity

Temperature	Relative Humidity
-40°F to 140°F (-40° to 60°C)	5% to 85% non-condensing

Ship the Printer

If you must ship the printer:

- Turn off (O) the printer, and disconnect all cables.
- Remove any media cartridges from the printer.
- Make sure that upper cover is closed.
- Carefully pack the printer into the original container or a suitable alternate container to avoid damage during transit. A shipping container can be purchased from Zebra if the original packaging has been lost or destroyed.

Preparing the Printer for Use

To prepare the printer for use, select an appropriate location for the printer, connect the appropriate cables to the printer, turn on the printer power, and then select and insert a media cartridge.

Site Selection

Select a solid, level surface within reach of an available power outlet. To allow for proper ventilation and cooling, leave open space on all sides of the printer.



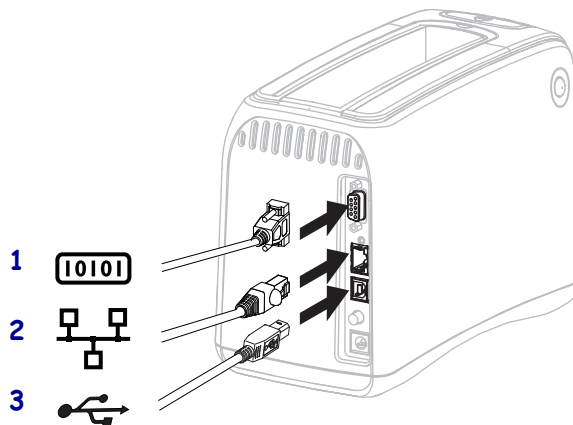
Caution • Do not place any padding or cushioning material under the unit or next to the back of the unit. This can prevent proper cooling and cause the unit to overheat.

Connect to Data Communication Interfaces

Select a data communication interface that is supported by both your printer and your computer or your Local Area Network (LAN). You may send wristband formats to the printer through any of its data communication ports.

Figure 10 shows the location of the data communication ports. Table 4 provides basic information about the data communication interfaces.

Figure 10 • Data Communication Ports



1	Serial port
2	Optional ZebraNet 10/100 Internal Print Server (wired Ethernet) port
3	USB port



Caution • Be careful not to plug a USB cable into the optional 10/100 wired Ethernet port on the printer. Doing so will damage the connector. The 10/100 wired Ethernet port comes with a plastic plug to protect it from accidental damage.

Table 4 • Characteristics of the Data Communication Interfaces

Interface	Standard or Optional	Characteristics
RS-232 Serial	Standard	<ul style="list-style-type: none"> • Maximum cable length of 50 ft (15.24 m). • You may need to change printer parameters to match the host computer. See <i>Changing and Restoring Printer Settings on page 44</i>. • You need to use a null-modem adaptor to connect to the printer if using a standard modem cable.
USB	Standard	<ul style="list-style-type: none"> • Maximum cable length of 16.4 ft (5 m). • No printer parameter changes required to match the host computer. • Requires installation of a printer driver. The driver is available at http://www.zebra.com/drivers or on the user CD that came with your printer.
ZebraNet 10/100 Internal Print Server (wired Ethernet)	Optional	<ul style="list-style-type: none"> • Can print to the printer from any computer on your LAN. • Can communicate with the printer through the printer's web pages. • The printer must be configured to use your LAN. See <i>Setting, Changing, and Restoring Print Server Settings on page 52</i>.
ZebraNet Internal Wireless Print Server (wireless Ethernet, 802.11b/g)	Optional	<ul style="list-style-type: none"> • Can print to the printer from any computer on your Wireless Local Area Network (WLAN) or LAN. • Can communicate with the printer through the printer's web pages. • The printer must be configured to use your WLAN. See <i>Setting, Changing, and Restoring Print Server Settings on page 52</i>.

Use of Shielded Data Cables Ethernet cables do not require shielding, but all other data cables must be fully shielded and fitted with metal or metallized connector shells. Unshielded data cables may increase radiated emissions above the regulated limits.

Connect to Power Source and Turn on Power

After you connect to a data communication interface, you may connect the printer to a power source and turn the power on.



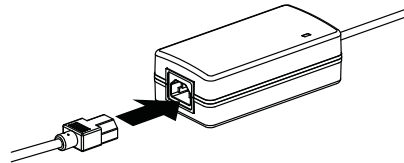
Caution • For personnel and equipment safety, always use an approved three-conductor power cord specific to the region or country intended for installation. This cord must use an IEC 320 female connector and the appropriate region-specific three-conductor grounded plug configuration.

To connect the printer to a power source and turn on the power, complete these steps:

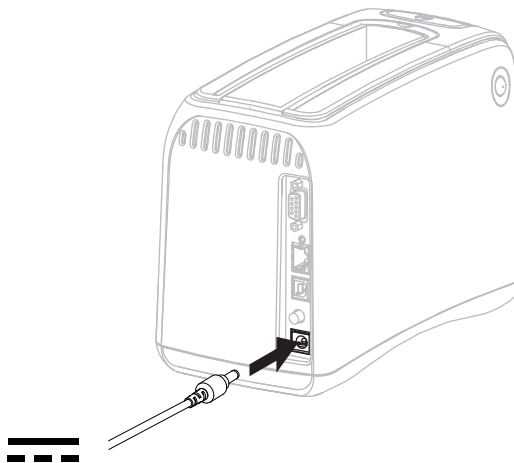
1. Locate the two parts of the power cord assembly. The power cord assembly consists of an A/C power cord (1) and a low-voltage D/C cord that is attached to a power supply (2) (Zebra model number FSP070-RDBM). If an A/C power cord was not included with your printer, refer to [Power Cord on page 63](#) for specifications.



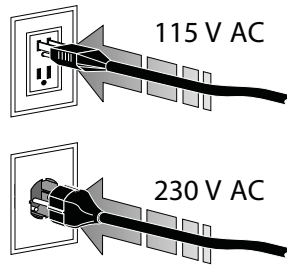
2. Insert the female end of the A/C power cord into the power supply.



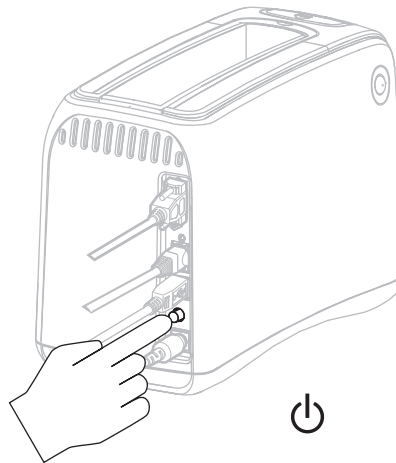
3. Insert the low-power D/C cord into the D/C power connector on the back of the printer.



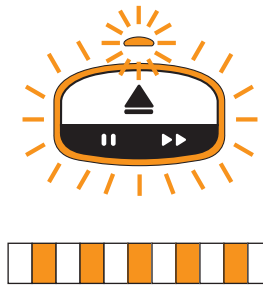
4. Plug the male end of the A/C power cord into an appropriate power outlet.



5. Push the power button to turn on (I) the printer.



The printer performs a self-test, and the control panel cycles through the light colors. The media status indicator and the printer status indicator blink orange to indicate that there is no media in the printer.

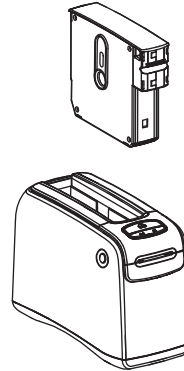


Insert Media Cartridge

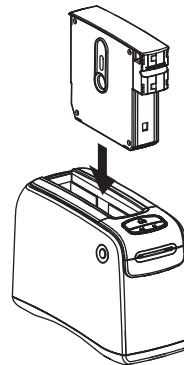
For more information about media cartridges and wristbands, see [Media Cartridges and Wristbands](#) on page 6.

To insert a media cartridge, complete these steps:

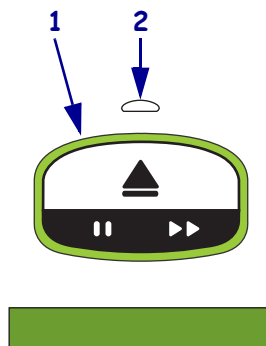
1. Orient the cartridge and the printer as shown.



2. Insert the cartridge into the printer, and then press down until the cartridge clicks.



The printer prepares a wristband for printing. With a new cartridge, the printer status indicator (1) turns green, and the media status indicator (2) remains off. For other media conditions, see [Media Status Indicator](#) on page 20.





Notes • _____



Troubleshooting

This section includes the meaning of various printer status lights.

Contents

Media Status Indicator	20
Printer Status Indicator	22
Wireless Status Indicator	25
Miscellaneous Troubleshooting	26

Media Status Indicator

Table 5 shows how the media status indicator and printer status indicator display different media levels or media errors. For light sequences not included here, see *Printer Status Indicator* on page 22.

Table 5 • Media Status Indicator Lights


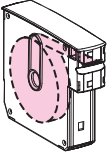

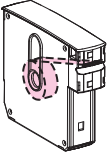

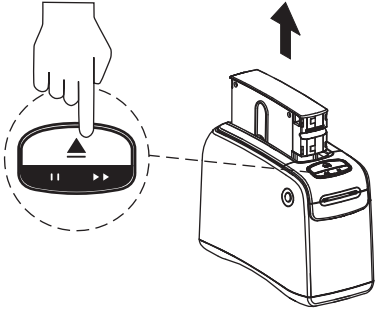
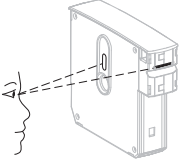

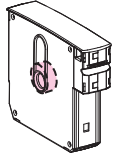
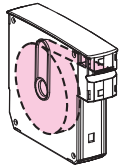
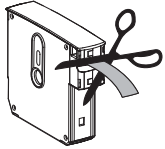
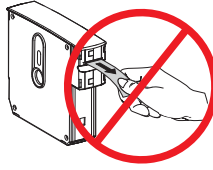
Media Status Indicator/ Printer Status Indicator	Meaning/Action Required
<p style="text-align: center;">Off/ Green</p> 	<p>The printer is ready to print. The media cartridge still contains a substantial number of wristbands. No action is required.</p> 
<p style="text-align: center;">Solid Orange/ Green</p> 	<p>The media level is low in the media cartridge (usually 20 or fewer wristbands). The printer can still continue to print. To order replacement media cartridges, see <i>Contacts</i> on page vii.</p> 
<p style="text-align: center;">Blinking Orange/ Blinking Orange</p> 	<p>A media error occurred.</p> <p>To resolve the problem, complete these steps:</p> <ol style="list-style-type: none"> 1. Push the Eject button, and then remove the media cartridge from the printer.  <ol style="list-style-type: none"> 2. Check the media cartridge for the level of media and for misfed wristbands.  <p style="text-align: center;">(continued on next page)</p>

Table 5 • Media Status Indicator Lights (Continued)

Media Status Indicator/ Printer Status Indicator	Meaning/Action Required
<p>Blinking Orange/ Blinking Orange</p> 	<p>(continued from previous page)</p> <p>3. If the media cartridge is...</p> <p>Empty</p> <ul style="list-style-type: none"> a. Dispose of or recycle the empty media cartridge according to your local ordinances. b. Insert a different media cartridge in the printer.  <p>Not empty</p> <ul style="list-style-type: none"> a. Reinsert the media cartridge into the printer. b. If the error persists, clean the smart card on the media cartridge and the media cartridge sensor (see Cleaning the Smart Card Contacts and the Media Cartridge Sensor Pins on page 38). c. If the error reoccurs after cleaning, replace the media cartridge. d. If the error reoccurs with a different media cartridge, contact technical support (see Contacts on page vii). <p>Not empty, but wristbands are protruding from the cartridge or jamming in the printer</p> <p>Media is not loading correctly.</p>  <ul style="list-style-type: none"> a. Cut off the protruding part of the wristband. Do NOT pull the wristband out of the media cartridge, or you will damage the media cartridge.   <ul style="list-style-type: none"> b. Reinsert the cartridge into the printer. c. If the error reoccurs, replace the media cartridge. d. If the error reoccurs with a different media cartridge, contact technical support (see Contacts on page vii).

Printer Status Indicator

In alert and error conditions, the printer status indicator lights may be on, blinking, or rotating. [Table 6](#) describes the different lights and light sequences. See [Control Panel Lights on page 4](#) for information about how the light sequences are indicated.

Table 6 • Lights and Light Sequences for Alert and Error Conditions








Light or Light Sequence	Meaning	Action Required
Steady Green 	The printer is ready to print.	None
Rotating Green 	The printer is downloading or processing data.	None.
Rotating Green Fill 	The printer is defragmenting or initializing flash memory.	None.
Steady Green, 2 Blinks Off 	The printer is paused.	Press PAUSE/FEED to resume printing.
Flashing Green then Orange 	The printer is in forced download mode.	Download firmware to the printer, or power cycle the printer to return to regular printing mode.
Steady Half-Orange, Half-Green 	The printer is writing to flash after a firmware download.	None. Caution • Do not power cycle the printer during this phase. Doing so makes the printer inoperable.
Steady Yellow 	A forced eject of the media cartridge is being initiated by pressing and holding EJECT. The printer will ultimately eject the media cartridge when the button is released, but it may be a forced eject or a normal eject.	<ul style="list-style-type: none"> • To cancel the forced eject and eject the media cartridge normally, release EJECT before the printer status indicator blinks yellow. • To proceed with the forced eject, continue to hold EJECT (about 6 seconds) until the printer status indicator blinks yellow. <p>After the forced eject, press the upper cover release buttons to open the printer's upper cover and release the wristband. See Media Cartridges on page 6 for information on removing the wristband from the cartridge. Do NOT pull the remainder of the wristband out of the cartridge.</p>

Table 6 • Lights and Light Sequences for Alert and Error Conditions (Continued)

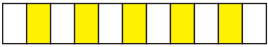










Light or Light Sequence	Meaning	Action Required
<p>Flashing Yellow</p> 	<p>A forced eject of the media cartridge is pending.</p>	<p>Release EJECT to allow the printer to force eject the media cartridge.</p>
<p>Rotating Yellow Fill</p> 	<p>The printhead reached temperature fail safe mode.</p>	<p> Caution • The printhead may be hot and could cause severe burns. Allow the printhead to cool.</p> <ol style="list-style-type: none"> 1. Turn the printer off (O). 2. Wait for the printhead to cool. 3. Turn the printer back on (I). 4. If the problem persists, repeat steps 1 and 2 and then make sure that the printhead cables are connected properly. 5. If the problem persists after checking the cables, contact technical support (see Contacts on page vii).
<p>Steady Orange</p> 	<p>If the color lasts for more than 3 seconds, one of the following conditions exists:</p> <ul style="list-style-type: none"> • The printhead is too cold. • The printhead is too hot. • The platen motor is too hot. 	<p>Wait a few minutes. If the platen motor is causing the problem, printing resumes when it cools. If printing does not resume, do the following:</p> <p> Caution • The printhead may be hot and could cause severe burns. Allow the printhead to cool.</p> <ol style="list-style-type: none"> 1. Turn the printer off (O). 2. Wait for the printhead to cool. 3. Turn the printer back on (I). 4. If the problem persists, repeat steps 1 and 2 and then make sure that the printhead cables are connected properly. 5. If the problem persists after checking the cables, contact technical support (see Contacts on page vii).






Table 6 • Lights and Light Sequences for Alert and Error Conditions (Continued)

Light or Light Sequence	Meaning	Action Required
Flashing Orange 	A media error occurred. 	See <i>Media Status Indicator</i> on page 20.
	The printer's upper cover is open. 	Make sure that the upper cover is closed and latched. If the problem persists, contact technical support (see <i>Contacts</i> on page vii).
Rotating Orange 	A wristband was waiting to be removed when the printer tried to eject the media cartridge.	Tear off the wristband that is hanging outside the printer before trying again to eject the media cartridge.
Steady Orange, 2 Blinks Off 	The printer is paused because one of the following conditions exists: <ul style="list-style-type: none"> The printer encountered an error while downloading a wristband format, a graphic, a font, or a bitmap. The printer is out of memory. 	Press PAUSE/FEED to resume printing.
Flashing Yellow then Orange 	PAUSE/FEED was pressed and held during printer power up. The printer can initiate forced download mode.	Release PAUSE/FEED during the 3 seconds that these lights flash to enter forced download mode. If you hold PAUSE/FEED longer than 3 seconds, the printer boots up normally.

Wireless Status Indicator

Table 7 describes the meaning of the wireless status indicator lights. For more information about the wireless print server, see the *ZebraNet Wireless User Guide*. A copy of this manual is available at <http://www.zebra.com/manuals> or on the user CD that came with your printer.

Table 7 • Wireless Status Indicator Lights

Wireless Status Indicator	Meaning
<p>Steady Green</p> 	<p>The printer is associated with a wireless network. The signal strength is strong.</p>
<p>Flashing Green</p> 	<p>The printer is NOT associated with a wireless network. The signal strength is strong.</p>
<p>Steady Orange</p> 	<p>The printer is associated with a wireless network. The signal strength is weak.</p>
<p>Flashing Orange</p> 	<p>The printer is NOT associated with a wireless network. The signal strength is weak.</p>
<p>OFF</p> 	<p>The wireless status indicator will turn off when wireless networks are not found.</p>

Miscellaneous Troubleshooting

Table 8 lists troubleshooting situations that are not necessarily shown by the status indicators.

Table 8 • Miscellaneous Troubleshooting

Problem	Meaning/Action Required
Data is not printing on the first part of the wristband.	You cannot print on the leading edge of each wristband. Redesign your wristband format so that it fits in the recommended print zone. See Wristband Print Zone on page 10 .
Data prints poorly on some sections of the wristband.	Printing on uncoated areas, over holes, or over scores affects print quality. Redesign your wristband format so that it fits in the recommended print zone. See Wristband Print Zone on page 10 .
The print darkness is unusually high.	Because direct thermal media is sensitive to temperature, this problem can occur in environments with high ambient temperature and high relative humidity. Use a lower darkness value while extreme high temperature or humidity conditons exist. <ol style="list-style-type: none"> 1. Set the darkness mode to USER or RELATIVE. See Select Darkness Mode on page 44. 2. Set the print darkness value to a lower value. See Adjust Print Darkness on page 45.
Wristbands will not load from a particular media cartridge.	The printer is not detecting the media cartridge. Clean the smart card contacts on the media cartridge and the pins on the media cartridge sensor (see Cleaning the Smart Card Contacts and the Media Cartridge Sensor Pins on page 38).
	The media cartridge is damaged. This can occur if someone pulls a wristband out of the media cartridge. If you believe that the media cartridge was damaged when you received it, contact your authorized Zebra reseller. Otherwise, dispose of or recycle the media cartridge. To order replacement media cartridges, see Contacts on page vii .
	The media cartridge is refurbished. Only Genuine Zebra™ supplies will work with your printer. Dispose of or recycle the media cartridge. To order replacement media cartridges, see Contacts on page vii .
Wristbands will not load from any media cartridge.	The printer is not detecting the media cartridge. Clean the pins on the media cartridge sensor (see Cleaning the Smart Card Contacts and the Media Cartridge Sensor Pins on page 38). If the problem persists, have the printer repaired by a qualified service technician.

Table 8 • Miscellaneous Troubleshooting (Continued)

Problem	Meaning/Action Required
Wristbands consistently jam or do not load correctly.	<p>The printer might not be detecting the black mark on the back of the wristbands.</p> <ol style="list-style-type: none"> 1. Replace the media cartridge. 2. If the problem persists with a different media cartridge, have a qualified service technician check and possibly replace the media sensor.
The printer will not eject the media cartridge.	<ol style="list-style-type: none"> 1. Turn the printer off (O) and then back on (I). 2. If the problem persists, initiate a forced eject. <ol style="list-style-type: none"> a. Press and hold EJECT for at least 6 seconds. The printer status indicator turns yellow after 2 seconds and flashes yellow after 6 seconds. b. Release EJECT after the printer status indicator flashes. c. Press the upper cover release buttons to open the printer's upper cover and release the wristband. d. See Media Cartridges on page 6 for information on removing the wristband from the cartridge. Do NOT pull the remainder of the wristband out of the cartridge. e. Close the upper cover. 3. If the problem persists, contact technical support (see Contacts on page vii).
The printer overheats.	<p>Improper ventilation may be causing the printer to overheat. Check that the printer has open spaces on all sides. The printer should be on a flat, level surface. Do not place objects on top of the printer.</p>



Notes • _____



Routine Maintenance

This section includes routine cleaning procedures and recycling information.

Contents

Cleaning the Media Path	30
Using a Cleaning Card	30
Using a Swab	32
Cleaning the Smart Card Contacts and the Media Cartridge Sensor Pins	38
Replacing Printer Components	40
Ordering Replacement Parts	40
Recycling Printer Components	40
Lubrication	40

Cleaning the Media Path

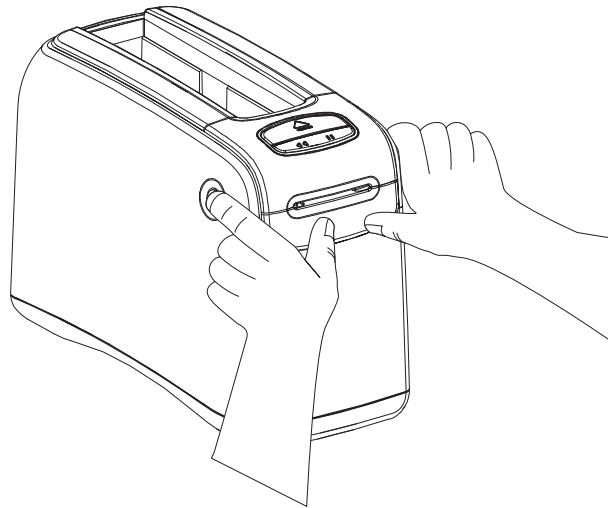
For best results, clean the media path after each cartridge of media. You can clean the media path using a cleaning card or using a swab.

Using a Cleaning Card

For cleaning cards, order part number 61332M. For ordering information, see [Contacts on page vii](#).

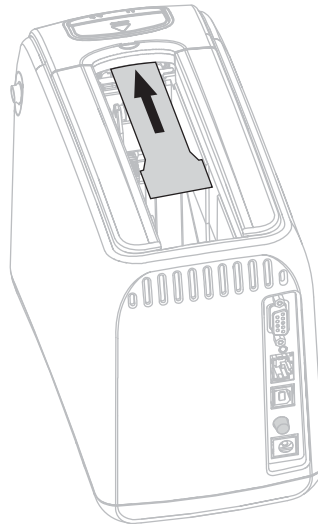
To clean the media path using a cleaning card, complete these steps:

1. Press EJECT, and then remove the media cartridge from the printer.
2. Turn off (O) the printer power.
3. Remove the cleaning card from its packaging.
4. Press both upper cover release buttons simultaneously.



The upper cover springs partially open.

5. Insert the cleaning card into the media chute as shown until 1/4 in. (6 mm) is visible from the front of the printer.



6. Close the upper cover.
7. Press and hold EJECT.
8. Turn on (I) the printer power.
9. Hold EJECT for approximately 15 seconds while the printer powers up and performs a self-test.
10. Release EJECT when the cleaning card begins moving.
 The printer uses the cleaning card to clean the media path.



11. **Caution** • The cleaning card contains isopropyl alcohol, a flammable material. After use, discard according to your local regulations.

Cleaning is complete when the card stops moving and returns to its original position.
 When cleaning is completed, remove and dispose of the cleaning card.

12. Reinsert the media cartridge.

Using a Swab

Use the swab from a Preventive Maintenance Kit (part number 47362) or a clean swab dipped in a solution of isopropyl alcohol (minimum 90%) and deionized water (maximum 10%).

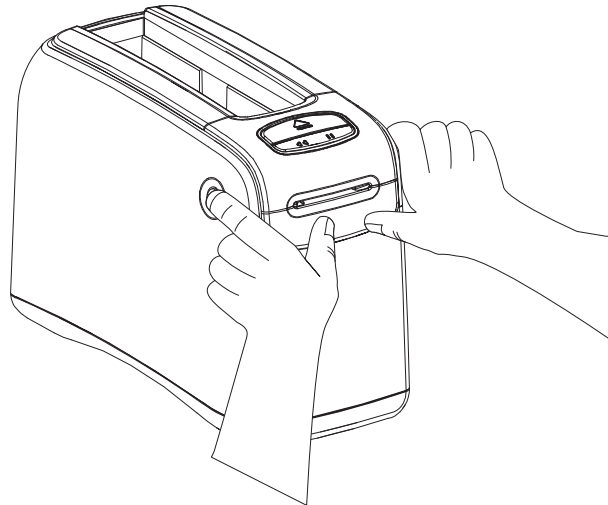
Caution • Remove all rings, watches, hanging necklaces, identification badges, or other metallic objects that could touch the printhead or drop into the media cartridge slot.



Caution • Before proceeding, discharge any built-up static electricity by touching the printer's metal back plate near its power switch or by using an anti-static wriststrap and mat.

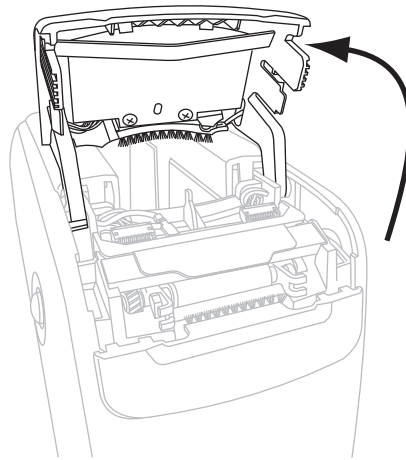
To clean the media path using a swab, complete these steps:

1. Press the Eject button, and remove the media cartridge from the printer.
2. Turn off (O) the printer power.
3. Press both upper cover release buttons simultaneously.



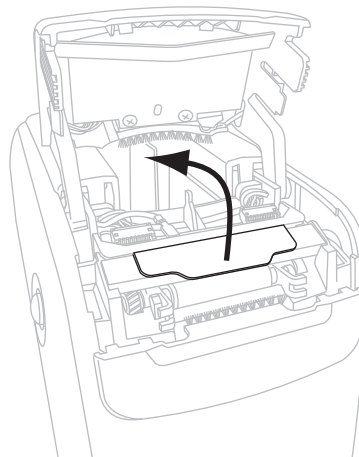
The upper cover springs partially open.

4. Rotate the upper cover up and back.



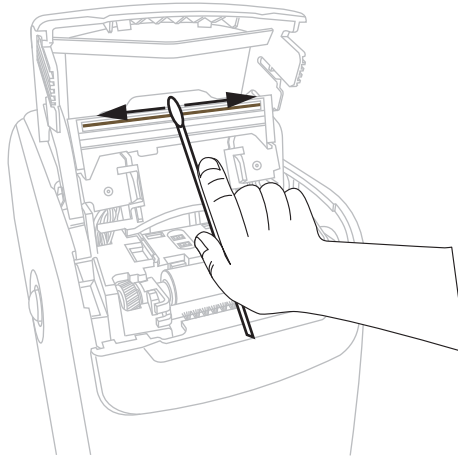
-
5. **Caution** • The printhead may be hot and could cause severe burns. Allow the printhead to cool.
-

Grasp the metal lever plate on the printhead assembly and rotate the assembly upward to expose the printhead elements.



6. Clean the printhead elements.

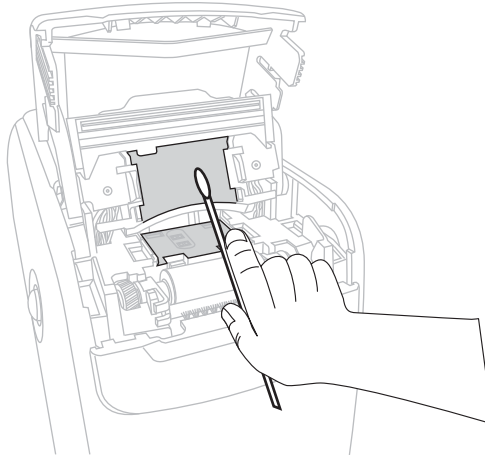
- a.** Using the swab from the Preventive Maintenance Kit or a swab dipped in the alcohol solution, wipe along the brown strip on the printhead assembly from end to end.



- b.** Allow the solution to evaporate.

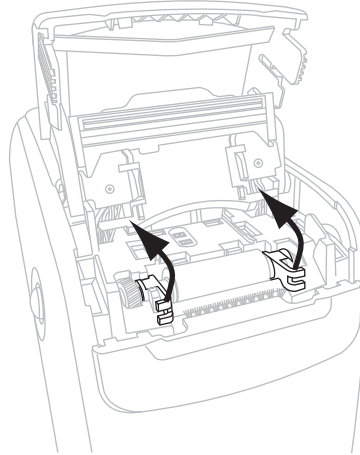
7. Clean the media guide surfaces.

- a.** Using the swab, wipe the media chute surfaces.

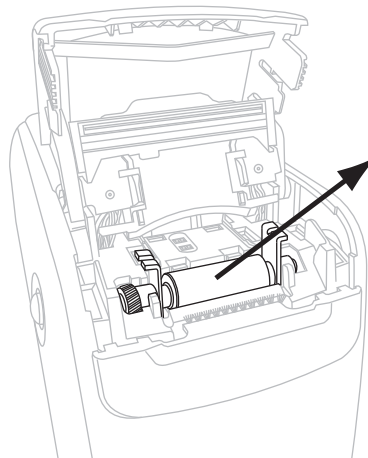


- b.** Allow the solution to evaporate.

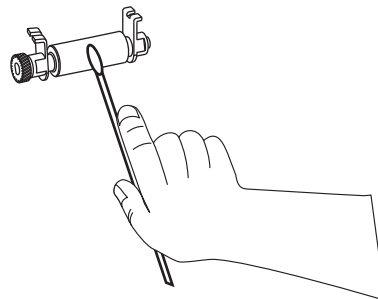
8. Rotate the two side clips on the platen roller upward.



9. Remove the platen roller from the printer.

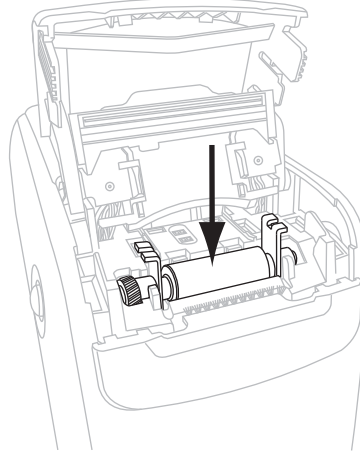


10. Clean the platen roller.
 - a. Using the swab, thoroughly clean the platen roller.

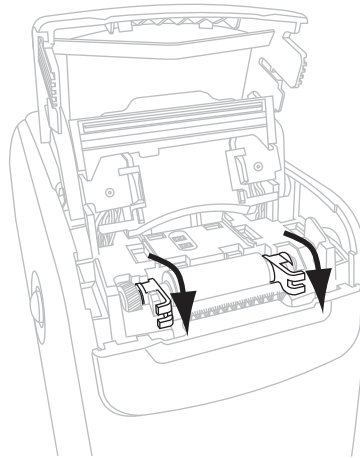


- b. Allow the solution to evaporate.

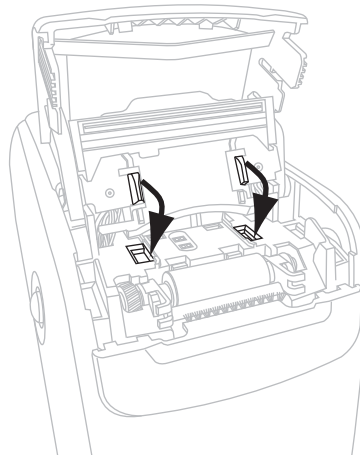
11. Place the platen roller back into its place in the printer.



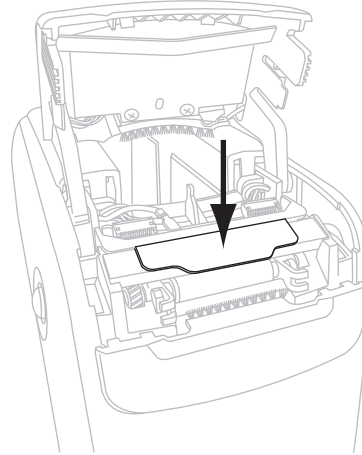
12. Secure the platen roller by rotating the two side clips back into place.



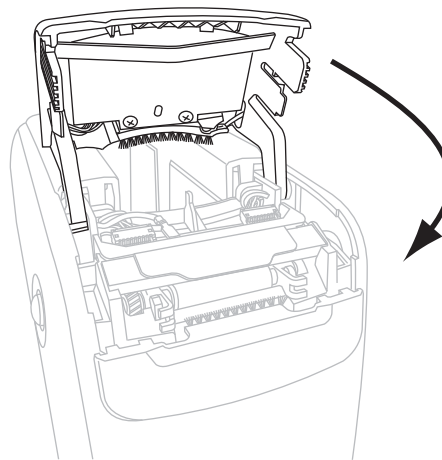
13. Align the snap tabs on the bottom of the media chute with the slots in the printer chassis.



14. Press down on the metal lever plate to snap the printhead assembly back into place.



15. Close the upper cover.



16. Turn on (I) the printer power.
17. Reinsert the media cartridge.
18. Discard the used swab.

Cleaning the Smart Card Contacts and the Media Cartridge Sensor Pins

After every five media cartridges, clean the media cartridge sensor pins to ensure that they make good contact with the smart card contacts on the media cartridge. If the printer will not detect a media cartridge, cleaning the media cartridge sensor pins and the smart card contacts on the cartridge may correct the problem. Use the swab from a Preventive Maintenance Kit (part number 47362) or a clean swab dipped in a solution of isopropyl alcohol (minimum 90%) and deionized water (maximum 10%).

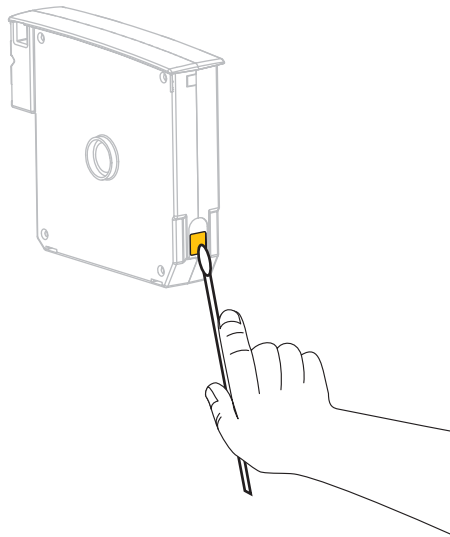
Caution • Remove all rings, watches, hanging necklaces, identification badges, or other metallic objects that could touch the printhead or drop into the media cartridge slot.



Caution • Before proceeding, discharge any built-up static electricity by touching the printer's metal back plate near its power switch or by using an anti-static wriststrap and mat.

To clean the smart card contacts and the media cartridge sensor pins, complete these steps:

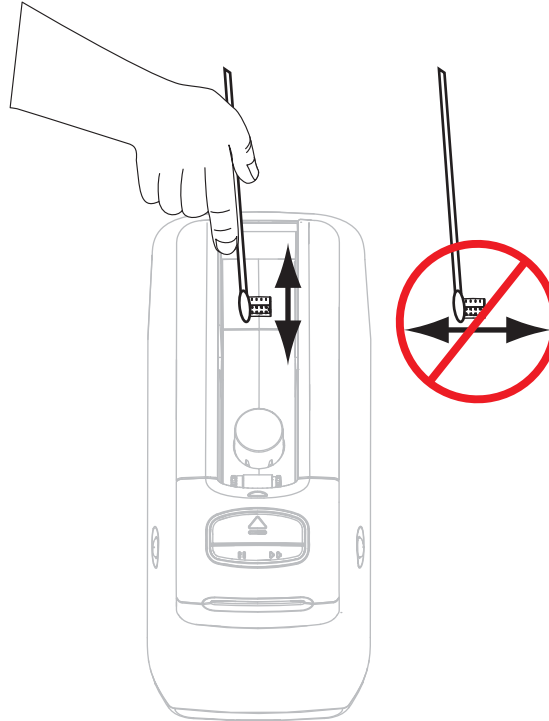
1. Press the Eject button, and remove the media cartridge from the printer.
2. Turn off (O) the printer power.
3. Disconnect the low-power D/C cord from the D/C power connector on the back of the printer.
4. Using the swab from the Preventive Maintenance Kit or a swab dipped in the alcohol solution, clean the gold smart card contacts on the back of the media cartridge. Allow the solution to evaporate.



5. **Caution** • Use only vertical strokes to clean the media cartridge sensor pins. Using horizontal strokes could damage the pins.

Clean the media cartridge sensor pins.

- a. Using the swab and vertical strokes, clean the gold media cartridge sensor pins, which are visible at the back of the media cartridge slot.



- b. Allow the solution to evaporate.

6. Insert the low-power D/C cord into the D/C power connector on the back of the printer.
7. Turn on **(I)** the printer power.
8. Reinsert the media cartridge.
9. Discard the used swab.

Replacing Printer Components

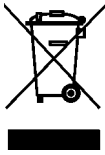
Some printer components, such as the printhead and platen roller, may wear out over time and can be replaced easily. Regular cleaning may extend the life of some of these components.

Ordering Replacement Parts

For optimal printing quality and proper printer performance across our product line, Zebra strongly recommends the use of Genuine Zebra™ supplies as part of the total solution.

Contact your authorized Zebra reseller for part ordering information, or see [Contacts on page vii](#) for contact addresses and telephone numbers.

Recycling Printer Components



The majority of this printer's components are recyclable. Do not dispose of any printer components in unsorted municipal waste. Please recycle the printer components according to your local standards. For more information, see <http://www.zebra.com/environment>.

Lubrication

No lubrication is needed for this printer.

Caution • Some commercially available lubricants will damage the finish and the mechanical parts if used on this printer.



Advanced User Information

This section contains information and instructions that are intended only for advanced users or service technicians.

Contents

Viewing Printer Settings	42
On a Printer Configuration Wristband	42
Through the Printer's Web Pages	43
Changing and Restoring Printer Settings	44
Setting, Changing, and Restoring Print Server Settings	52
Connecting for the First Time	52
Changing Parameters after Connecting	52
Web Pages	56
Additional Diagnostics Tools	58
Media Sensor Profile	58
Communications Diagnostics Test	59
Downloading Firmware	60

Viewing Printer Settings

The printer configuration wristband provides some basic information about the printer, particularly about the connectivity settings. If your printer has an active Ethernet wired or wireless connection, you can view all of the printer's settings through the printer's web pages.

On a Printer Configuration Wristband

A printer configuration wristband (Figure 11) shows the printer's connectivity settings and the wristband tear-off position. The IP ADDRESS and MAC ADDRESS fields will have values only if a wired or wireless print server is active. The USB COMM field shows if the printer is connected to a computer via the USB connector.

Figure 11 • Sample Printer Configuration Wristband

PRINTER CONFIGURATION	
+000.....	TEAR OFF
CONNECTED.....	USB COMM.
9600,B,N,2,X,N,^,,	SERIAL COMM.
ZV54.16.0Z<.....	FIRMWARE
000.000.000.000....	IP ADDRESS
00000000000	MAC ADDRESS
FIRMWARE IN THIS PRINTER IS COPYRIGHTED	

To print a printer configuration wristband, complete these steps:

1. Make sure that the printer is on (I) and ready to print.
2. Press and hold PAUSE/FEED until the green lights turn off on the printer status indicator and the orange lights blink once.
3. Release PAUSE/FEED.
A printer configuration wristband prints.

Through the Printer's Web Pages

The View Printer Configuration web page is shown in [Figure 12](#). You can access this page for your printer by clicking **View Printer Configuration** on the printer home page. For more information about the web pages, see [Web Pages on page 56](#).

Figure 12 • View Printer Configuration Web Page (Printer Default Values Shown)

View Printer Configuration

```

2012-06-07 18:42:25      TIME STAMP
JDI017539.11BHG080125.61600-011.K.11
+22                      DARKNESS
CARTRIDGE                DARKNESS MODE
4 IPS                    PRINT SPEED
300                      PRINT WIDTH
+000                     TEAR OFF
2862                     LABEL LENGTH
39.0IN  988MM           MAXIMUM LENGTH
NOT CONNECTED           USB COMM.
RS232                    SERIAL COMM.
115200                   BAUD
8 BITS                   DATA BITS
NONE                     PARITY
RTS/CTS                  HOST HANDSHAKE
NONE                     PROTOCOL
000                      NETWORK ID
NORMAL MODE              COMMUNICATIONS
<~> 7EH                 CONTROL PREFIX
<^> 5EH                 FORMAT PREFIX
<,> 2CH                 DELIMITER CHAR
ZPL II                   ZPL MODE
INACTIVE                 COMMAND OVERRIDE
+000                     LABEL TOP
+0000                    LEFT POSITION
DISABLED                 REPRINT MODE
DISABLED                 ZBI
2.1                      ZBI VERSION
DPSWFXM                 MODES ENABLED
.....                 MODES DISABLED
  672 12/MM FULL        RESOLUTION
V54.17.12ZP07 <-      FIRMWARE
1.3                     XML SCHEMA
V39 ----- 36        HARDWARE ID
002                     CART DATA VER
CUSTOMIZED              CONFIGURATION
10368k.....R:         RAM
2048k.....E:          ONBOARD FLASH
NONE                   FORMAT CONVERT
1,894 IN               NONRESET CNTR
630 IN                 RESET CNTR1
630 IN                 RESET CNTR2
4,810 CM               NONRESET CNTR
1,600 CM               RESET CNTR1
1,600 CM               RESET CNTR2

```



Important • If you select the Print on Label option, a printer configuration wristband prints (see [Figure 11 on page 42](#)).

Changing and Restoring Printer Settings

By default, the printer automatically adjusts the settings based on the type of media cartridge that you insert. You will not usually need to adjust these settings. If necessary, you can adjust the printer settings to obtain optimal print quality or to change connectivity parameters. You do this through Zebra Programming Language II (ZPL II) commands, Set/Get/Do (SGD) commands, or through the printer's web pages. The printer requires an active wired or wireless Ethernet connection for you to access the printer's web pages.

For the ZPL commands and SGD commands, see the *ZPL II Programming Guide*. A copy of this manual is available at <http://www.zebra.com/manuals> or on the user CD that came with your printer. For instructions on accessing the printer's web pages, see [Web Pages on page 56](#).

Table 9 shows the printer parameters and what you can use to modify them.

Table 9 • Printer Parameters

Parameter	Details
DARKNESS MODE	<p>Select Darkness Mode</p> <p>The printer has three darkness modes, which determine how the DARKNESS value is set.</p> <p><i>Default Value:</i> CARTRIDGE</p> <p><i>Selections:</i></p> <ul style="list-style-type: none"> • CARTRIDGE—DARKNESS is set to the media cartridge default value. No changes are allowed, and the printer ignores ZPL commands that change the darkness value. • USER—DARKNESS is set by the user, and the printer ignores the media cartridge default value. This darkness value is used for all media cartridges that are inserted into the printer. • RELATIVE—DARKNESS is stored as the difference between the current darkness setting and the current media cartridge default value. The printer adds this difference to the default darkness value of any subsequent media cartridges. <p><i>Corresponding ZPL Command:</i> None</p> <p><i>Corresponding SGD Command:</i> <code>media.darkness_mode</code></p> <p><i>Located on Web Page:</i> General Setup</p>

Table 9 • Printer Parameters (Continued)


Parameter	Details
DARKNESS	<p>Adjust Print Darkness Change the darkness setting if the wristbands print too light or too dark.</p> <p> Important • To ensure the best image durability, set the darkness to the highest setting that provides good print quality and bar codes that scan consistently. If the darkness is set too high, bar codes may not scan, or the printhead may wear prematurely.</p> <p><i>Default Value:</i> This value varies depending on the darkness mode and the media cartridge being used. Typically, the value is +21.</p> <p><i>Corresponding ZPL Command:</i> ~SD, ^MD (available when the darkness mode is set to USER or RELATIVE; ignored when the darkness mode is set to CARTRIDGE)</p> <p><i>Corresponding SGD Command:</i> None</p> <p><i>Located on Web Page:</i> General Setup</p>
PRINT WIDTH	<p>Set Print Width This parameter is set automatically by the printer cartridge. It cannot be modified. The ^PW ZPL II command is ignored.</p> <p><i>Located on Web Page:</i> Media Setup (view only)</p>
TEAR OFF	<p>Adjust the Tear-Off Position This parameter adjusts the resting position of the wristband after printing. Higher numbers move the wristband farther out of the printer while lower numbers move the wristband farther inside the printer.</p> <p><i>Default Value:</i> +0 <i>Range:</i> +0 to +120</p> <p><i>Corresponding ZPL Command:</i> ^TA <i>Corresponding SGD Command:</i> None</p> <p><i>Located on Web Page:</i> General Setup</p>
LABEL LENGTH	<p>Set Wristband Length This parameter is set automatically by the printer cartridge. It cannot be modified. The ^LL ZPL II command is ignored.</p>
MAXIMUM LENGTH	<p>Set Maximum Wristband Length This parameter is set automatically by the printer cartridge. It cannot be modified. The ^ML ZPL II command is ignored.</p> <p><i>Located on Web Page:</i> Media Setup (view only)</p>
SERIAL	<p>Set Serial Communications Select the communications port that matches the one being used by the host computer. This setting applies only when the serial port is used.</p> <p><i>Default Value:</i> RS232 <i>Selections:</i> RS232, RS485 MULTIDROP</p> <p><i>Corresponding ZPL Command:</i> ^SC <i>Corresponding SGD Command:</i> None</p> <p><i>Located on Web Page:</i> Serial Communications Setup</p>

Table 9 • Printer Parameters (Continued)

Parameter	Details
BAUD	<p>Set Baud</p> <p>This setting applies only when the serial port is used. The baud setting of the printer must match the baud setting of the host computer for accurate communications to take place. Select the value that matches the one being used by the host computer.</p> <p><i>Default Value:</i> 9600 <i>Selections:</i> 300, 600, 1200, 2400, 4800, 9600, 14400, 19200, 28800, 38400, 57600, 115200</p> <p><i>Corresponding ZPL Command:</i> ^SC <i>Corresponding SGD Command:</i> None <i>Located on Web Page:</i> Serial Communications Setup</p>
DATA BITS	<p>Set Data Bits</p> <p>This setting applies only when the serial port is used. The data bits of the printer must match the data bits of the host computer for accurate communications to take place. Set the data bits to match the setting being used by the host computer.</p> <p><i>Default Value:</i> 8 BITS <i>Selections:</i> 7 BITS, 8 BITS</p> <p><i>Corresponding ZPL Command:</i> ^SC <i>Corresponding SGD Command:</i> None <i>Located on Web Page:</i> Serial Communications Setup</p>
PARITY	<p>Set Parity</p> <p>This setting applies only when the serial port is used. The parity of the printer must match the parity of the host computer for accurate communications to take place. Select the parity that matches the one being used by the host computer.</p> <p><i>Default Value:</i> NONE <i>Selections:</i> EVEN, ODD, NONE</p> <p><i>Corresponding ZPL Command:</i> ^SC <i>Corresponding SGD Command:</i> None <i>Located on Web Page:</i> Serial Communications Setup</p>
HOST HANDSHAKE	<p>Set Host Handshake</p> <p>This setting applies only when the serial port is used. The handshake protocol of the printer must match the handshake protocol of the host computer for communication to take place. Select the handshake protocol that matches the one being used by the host computer.</p> <p><i>Default Value:</i> XON/XOFF <i>Selections:</i> XON/XOFF, DSR/DTR, RTS/CTS</p> <p><i>Corresponding ZPL Command:</i> ^SC <i>Corresponding SGD Command:</i> None <i>Located on Web Page:</i> Serial Communications Setup</p>

Table 9 • Printer Parameters (Continued)


Parameter	Details
PROTOCOL	<p>Set Protocol</p> <p>Protocol is a type of error checking system. Depending on the selection, an indicator may be sent from the printer to the host computer signifying that data has been received. Select the protocol that is requested by the host computer. Further details on protocol can be found in the <i>ZPL II Programming Guide</i>.</p> <p><i>Default Value:</i> NONE <i>Selections:</i> NONE, ZEBRA, ACK_NAK</p> <p><i>Corresponding ZPL Command:</i> ^SC <i>Corresponding SGD Command:</i> None <i>Located on Web Page:</i> Serial Communications Setup</p>
NETWORK ID	<p>Set Network ID</p> <p>This parameter assigns a unique number to the printer when the printer is operating in an RS422/485 multi-drop network environment (an external RS422/485 adapter is required). This gives the host computer the means to address a specific printer. This does not affect TCP/IP or IPX networks.</p> <p><i>Default Value:</i> 000 <i>Range:</i> 000 to 999</p> <p><i>Corresponding ZPL Command:</i> ^NI <i>Corresponding SGD Command:</i> None <i>Located on Web Page:</i> Serial Communications Setup</p>
COMMUNICATIONS	<p>Set Communications Diagnostics Mode</p> <p>The communication diagnostics mode is a troubleshooting tool for checking the interconnection between the printer and the host computer. For more information, see Communications Diagnostics Test on page 59.</p> <p><i>Default Value:</i> NORMAL MODE <i>Selections:</i> NORMAL MODE, DIAGNOSTICS</p> <p><i>Corresponding ZPL Command:</i> ~JD to start, ~JE to stop <i>Corresponding SGD Command:</i> None <i>Located on Web Page:</i> None</p>
CONTROL PREFIX	<p>Set Control Prefix Character</p> <p>The printer looks for this two-digit hex character to indicate the start of a ZPL/ZPL II control instruction.</p> <p> Note • Do not use the same hex value for the control, format, and delimiter character. The printer must see different characters to work properly.</p> <p><i>Default Value:</i> 7E ~ <i>Range:</i> 00 to FF</p> <p><i>Corresponding ZPL Command:</i> ^CT or ~CT <i>Corresponding SGD Command:</i> None <i>Located on Web Page:</i> ZPL Control</p>

Table 9 • Printer Parameters (Continued)



Parameter	Details
<p>FORMAT PREFIX</p>	<p>Set Format Prefix Character</p> <p>The format prefix is a two-digit hex value used as a parameter place marker in ZPL/ZPL II format instructions. The printer looks for this hex character to indicate the start of a ZPL/ZPL II format instruction. See the <i>ZPL II Programming Guide</i> for more information.</p> <p> Note • Do not use the same hex value for the control, format, and delimiter character. The printer must see different characters to work properly.</p> <p><i>Default Value:</i> 5E ^ <i>Range:</i> 00 to FF <i>Corresponding ZPL Command:</i> ^CC or ~CC <i>Corresponding SGD Command:</i> None <i>Located on Web Page:</i> ZPL Control</p>
<p>DELIMITER CHAR</p>	<p>Set Delimiter Character</p> <p>The delimiter character is a two-digit hex value used as a parameter place marker in ZPL/ZPL II format instructions. See the <i>ZPL II Programming Guide</i> for more information.</p> <p> Note • Do not use the same hex value for the control, format, and delimiter character. The printer must see different characters to work properly.</p> <p><i>Default Value:</i> 2C , <i>Range:</i> 00 to FF <i>Corresponding ZPL Command:</i> ^CD or ~CD <i>Corresponding SGD Command:</i> None <i>Located on Web Page:</i> ZPL Control</p>
<p>ZPL MODE</p>	<p>Select ZPL Mode</p> <p>The printer remains in the selected mode until it is changed by this parameter or by using a ZPL/ZPL II command. The printer accepts wristband formats written in either ZPL or ZPL II, eliminating the need to rewrite any ZPL formats that already exist.</p> <p><i>Default Value:</i> ZPL II <i>Range:</i> ZPL II, ZPL <i>Corresponding ZPL Command:</i> ^SZ <i>Corresponding SGD Command:</i> None <i>Located on Web Page:</i> ZPL Control</p>



Table 9 • Printer Parameters (Continued)

Parameter	Details
LABEL TOP	<p>Adjust Top Position</p> <p>This parameter adjusts the print position vertically on the wristband. Positive numbers adjust the top position farther down the wristband (away from the printhead) by the specified number of dots. Negative numbers adjust the top position up the wristband (toward the printhead).</p> <p><i>Default Value:</i> +000 <i>Range:</i> +000 to +120 dots</p> <p><i>Corresponding ZPL Command:</i> ^LT <i>Corresponding SGD Command:</i> None <i>Located on Web Page:</i> General Setup</p>
LEFT POSITION	<p>Adjust Left Position</p> <p>This parameter adjusts the print position horizontally on the wristband. Positive numbers adjust printing to the left by the specified number of dots. Negative numbers shift printing to the right.</p> <p><i>Default Value:</i> 0000 <i>Range:</i> -9999 to +9999 dots</p> <p><i>Corresponding ZPL Command:</i> ^LS <i>Corresponding SGD Command:</i> None <i>Located on Web Page:</i> Advanced Setup</p>
REPRINT MODE	<p>Enable Reprint Mode</p> <p>When reprint mode is enabled, the printer reprints the last wristband after you correct an error condition.</p> <p><i>Default Value:</i> DISABLED <i>Selections:</i> ENABLED, DISABLED</p> <p><i>Corresponding ZPL Command:</i> ^JZ <i>Corresponding SGD Command:</i> None <i>Located on Web Page:</i> None</p>
ZBI	<p>Run ZBI 2.0</p> <p>If your printer was not factory-enabled with ZBI 2.0, you must purchase a ZBI 2.0 Activation Key to use ZBI 2.0. Contact your authorized Zebra reseller for more information.</p> <p><i>Default Value:</i> STOPPED (DISABLED) <i>Selections:</i> STARTED (ENABLED), STOPPED (DISABLED)</p> <p><i>Corresponding ZPL Command:</i> ^JI or ~JI to start, ~JQ to stop <i>Corresponding SGD Command:</i> zbi.control.run to start, zbi.control.terminate to stop <i>Located on Web Page:</i> None</p>

Table 9 • Printer Parameters (Continued)

Parameter	Details
FORMAT CONVERT	<p>Select Format Convert</p> <p>Selects the bitmap scaling factor. The first number is the original dots per inch (dpi) value; the second, the dpi to which you would like to scale.</p> <p><i>Default Value:</i> NONE</p> <p><i>Selections:</i> NONE, 150 → 300, 150 → 600, 200 → 600, 300 → 600</p> <p><i>Corresponding ZPL Command:</i> ^MU</p> <p><i>Corresponding SGD Command:</i> None</p> <p><i>Located on Web Page:</i> Advanced Setup</p>
NONRESET CNTR	<p>View Non-Resettable Counter</p> <p>This parameter displays the total length of media that the printer has printed. You can use ZPL commands to change the unit of measure for this counter.</p> <p><i>Corresponding ZPL Command:</i> ~HQ to view, ^MU to change unit of measure</p> <p><i>Corresponding SGD Command:</i> odometer.total_print_length</p> <p><i>Located on Web Page:</i> None</p>
RESET CNTR1	<p>View User-Controlled Counter 1</p> <p>This parameter displays the total length of media that the printer has printed since this parameter was last reset. You can use ZPL commands to change the unit of measure and reset this counter.</p> <p><i>Corresponding ZPL Command:</i> ~HQ to view, ~RO to reset, ^MU to change unit of measure</p> <p><i>Corresponding SGD Command:</i> odometer.media_marker_count1</p> <p><i>Located on Web Page:</i> None</p>
RESET CNTR2	<p>View User-Controlled Counter 2</p> <p>This parameter displays the total length of media that the printer has printed since this parameter was last reset. You can use ZPL commands to change the unit of measure and reset this counter.</p> <p><i>Corresponding ZPL Command:</i> ~HQ to view, ~RO to reset, ^MU to change unit of measure</p> <p><i>Corresponding SGD Command:</i> odometer.media_marker_count2</p> <p><i>Located on Web Page:</i> None</p>

Table 9 • Printer Parameters (Continued)

Parameter	Details
LOAD DEFAULTS	<p>Restore Printer Default Values</p> <p>Restores all parameters other than the network settings back to the factory defaults. Use care when loading defaults because you will need to reload all settings that you changed manually.</p> <p> Note • Loading factory defaults causes the printer to auto-calibrate.</p> <p><i>Corresponding ZPL Command:</i> ^JUF <i>Corresponding SGD Command:</i> None <i>Located on Web Page:</i> View and Modify Printer Settings (Restore Default Configuration button)</p> <p>To restore printer default values through the control panel, complete these steps:</p> <ol style="list-style-type: none"> 1. Press and hold PAUSE/FEED to place the printer in user configuration mode. The printer status indicator blinks orange. Depending on when you release PAUSE/FEED, different actions take place. 2. Release PAUSE/FEED after the orange light blinks four times. The printer resets all printer parameters back to defaults. The default values are shown in Figure 12 on page 43. <div style="text-align: center;">  </div>

Setting, Changing, and Restoring Print Server Settings

Your printer may include an optional ZebraNet 10/100 Internal Print Server (wired Ethernet) or a ZebraNet Internal Wireless Plus Print Server (wireless Ethernet).

For additional information, refer to the manuals for your wired or wireless print server. Copies of the manuals are available at <http://www.zebra.com/manuals> or on the user CD that came with your printer. For instructions on accessing the printer’s web pages, see *Web Pages on page 56*.

Connecting for the First Time

ZebraNet 10/100 Internal Print Server To configure the 10/100 Internal Print Server, connect the printer to your Local Area Network (LAN) using an Ethernet cable. By default, the printer is set for dynamic IP resolution, so it should acquire an IP address. Print a printer configuration wristband to find the printer’s IP address (see *Viewing Printer Settings on page 42*). If you need to change parameters before you can connect the first time, use the serial or USB port to send the appropriate ZPL or SGD commands.

ZebraNet Internal Wireless Print Server See the *ZebraNet Wireless User Guide* for configuration instructions. Before you can connect your printer to your Wireless Local Area Network (WLAN) or view the printer’s web pages, you need to set the printer’s parameters to match your WLAN. Use the serial or USB port to send the appropriate instructions to the printer.

After the printer connects to your WLAN, you can access the printer’s web pages to make changes to the settings. Print a printer configuration wristband to find the printer’s IP address (see *Viewing Printer Settings on page 42*).

Changing Parameters after Connecting

Table 9 shows basic print server parameters and what you can use to modify them. For all other print server parameters, refer to the manuals for your wired or wireless print server.

Table 10 • Print Server Parameters


Parameter	Details
IP ADDRESS	<p>View or Change the Printer’s IP Address</p> <p>This parameter can be modified only when PERMANENT is selected for IP PROTOCOL.</p> <p><i>Selections:</i> 0 to 255 for each field <i>Default Value:</i> 0.0.0.0</p> <p> Note • Leading zeroes are not shown in the address.</p> <p><i>Corresponding ZPL Command:</i> ^ND, ^NS (wired), or ^WI (wireless) <i>Corresponding SGD Command:</i> internal_wired.ip.addr (wired) or wlan.ip.addr (wireless)</p> <p><i>Located on Web Page:</i> TCP/IP Settings</p>

Table 10 • Print Server Parameters (Continued)



Parameter	Details
IP PROTOCOL	<p>Select the Method to Obtain an IP Address</p> <p>This parameter tells if the user (permanent) or the server (dynamic) selects the IP address. If a dynamic option is chosen, this parameter tells the method by which the print server (wired or wireless) receives the IP address from the server.</p> <p><i>Selections:</i> ALL, BOOTP, DHCP, DHCP AND BOOTP, PERMANENT</p> <p><i>Default Value:</i> All</p> <p><i>Corresponding ZPL Command:</i> ^ND, ^NS (wired), or ^WI (wireless)</p> <p><i>Corresponding SGD Command:</i> internal_wired.ip.protocol (wired) or wlan.ip.protocol (wireless)</p> <p><i>Located on Web Page:</i> TCP/IP Settings</p>
SUBNET MASK	<p>View or Change the Subnet</p> <p>This parameter can be modified only when PERMANENT is selected for IP PROTOCOL.</p> <p><i>Selections:</i> 0 to 255 for each field</p> <p><i>Default Value:</i> 255.255.255.0</p> <p> Note • Leading zeroes are not shown in the address.</p> <p><i>Corresponding ZPL Command:</i> ^ND, ^NS (wired), or ^WI (wireless)</p> <p><i>Corresponding SGD Command:</i> internal_wired.ip.netmask (wired) or wlan.ip.netmask (wireless)</p> <p><i>Located on Web Page:</i> TCP/IP Settings</p>
DEFAULT GATEWAY	<p>View or Change the Gateway</p> <p>This parameter can be modified only when PERMANENT is selected for IP PROTOCOL.</p> <p><i>Selections:</i> 0 to 255 for each field</p> <p><i>Default Value:</i> 0.0.0.0</p> <p> Note • Leading zeroes are not shown in the address.</p> <p><i>Corresponding ZPL Command:</i> ^ND, ^NS (wired), or ^WI (wireless)</p> <p><i>Corresponding SGD Command:</i> internal_wired.ip.gateway (wired) or wlan.ip.gateway (wireless)</p> <p><i>Located on Web Page:</i> TCP/IP Settings</p>

Table 10 • Print Server Parameters (Continued)




Parameter	Details
IP PROTOCOL	<p>Select the Method to Obtain an IP Address</p> <p>This parameter tells if the user (permanent) or the server (dynamic) selects the IP address. If a dynamic option is chosen, this parameter tells the method by which the print server (wired or wireless) receives the IP address from the server.</p> <p><i>Selections:</i> ALL, BOOTP, DHCP, DHCP AND BOOTP, PERMANENT</p> <p><i>Default Value:</i> All</p> <p><i>Corresponding ZPL Command:</i> ^ND, ^NS (wired), or ^WI (wireless)</p> <p><i>Corresponding SGD Command:</i> internal_wired.ip.protocol (wired) or wlan.ip.protocol (wireless)</p> <p><i>Located on Web Page:</i> TCP/IP Settings</p>
SUBNET MASK	<p>View or Change the Subnet</p> <p>This parameter can be modified only when PERMANENT is selected for IP PROTOCOL.</p> <p><i>Selections:</i> 0 to 255 for each field</p> <p><i>Default Value:</i> 255.255.255.0</p> <p> Note • Leading zeroes are not shown in the address.</p> <p><i>Corresponding ZPL Command:</i> ^ND, ^NS (wired), or ^WI (wireless)</p> <p><i>Corresponding SGD Command:</i> internal_wired.ip.netmask (wired) or wlan.ip.netmask (wireless)</p> <p><i>Located on Web Page:</i> TCP/IP Settings</p>
DEFAULT GATEWAY	<p>View or Change the Gateway</p> <p>This parameter can be modified only when PERMANENT is selected for IP PROTOCOL.</p> <p><i>Selections:</i> 0 to 255 for each field</p> <p><i>Default Value:</i> 0.0.0.0</p> <p> Note • Leading zeroes are not shown in the address.</p> <p><i>Corresponding ZPL Command:</i> ^ND, ^NS (wired), or ^WI (wireless)</p> <p><i>Corresponding SGD Command:</i> internal_wired.ip.gateway (wired) or wlan.ip.gateway (wireless)</p> <p><i>Located on Web Page:</i> TCP/IP Settings</p>

Table 10 • Print Server Parameters (Continued)

Parameter	Details
DEFAULT NET	<p>Restore Print Server Default Values Restores the wired and wireless network settings back to factory defaults.</p> <p><i>Corresponding ZPL Command:</i> ^JUN <i>Corresponding SGD Command:</i> none <i>Located on Web Page:</i> View and Modify Printer Settings (Restore Default Network Configuration button)</p> <p>To restore printer default values through the control panel, complete these steps:</p> <ol style="list-style-type: none"> 1. Press and hold PAUSE/FEED to place the printer in user configuration mode. The printer status indicator blinks orange. Depending on when you release PAUSE/FEED, different actions take place. 2. Release PAUSE/FEED after the orange light blinks three times. The printer resets all print server parameters back to defaults. <div style="text-align: center;">  </div>

Web Pages

If your printer has an active Ethernet wired or wireless connection, you can view and modify the printer's settings through the printer's web pages. For additional information, refer to the manuals for your wired or wireless print server. Copies of the manuals are available at <http://www.zebra.com/manuals> or on the user CD that came with your printer.

The printer home page is shown in [Figure 13](#).

Figure 13 • Printer Home Page



To access printer settings through the web pages, complete these steps:

1. On the printer home page, click **View and Modify Printer Settings**.
The printer prompts for a password.
2. Enter the password for your printer. The default password is **1234**.
3. Click **Submit Changes**.

The following statement appears:

Access Granted. This IP Address now has admin access to the restricted printer pages. Please Click here to proceed

4. Click on the statement.

The View and Modify Printer Settings page displays.



5. Modify the settings as needed.

For additional information, refer to the manuals for your wired or wireless print server. Copies of the manuals are available at <http://www.zebra.com/manuals> or on the user CD that came with your printer.

Additional Diagnostics Tools

The media sensor profile and the communications diagnostics test are available as diagnostic tools.

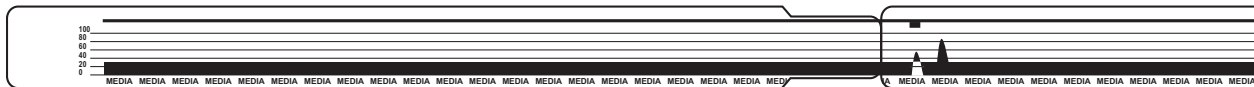
Media Sensor Profile

Use the media sensor profile to troubleshoot the following types of problems:

- If the media sensor experiences difficulty in determining where wristbands start and stop.
- If the media sensor incorrectly identifies a preprinted area on a wristband as the end of the wristband.

The media sensor readings are shown as peaks and flat areas on the media sensor profile (Figure 14). Two peaks appear when the sensors are operating properly, indicating that the sensors correctly detected the black mark on the back of the wristband. A media sensor profile prints on two wristbands.

Figure 14 • Media Sensor Profile



To print a media sensor profile, complete these steps:

1. Make sure that the printer is on (I) and ready to print.
2. Press and hold PAUSE/FEED until the green lights turn off on the printer status indicator and the orange lights blink once. Continue holding PAUSE/FEED until the orange lights blink twice.



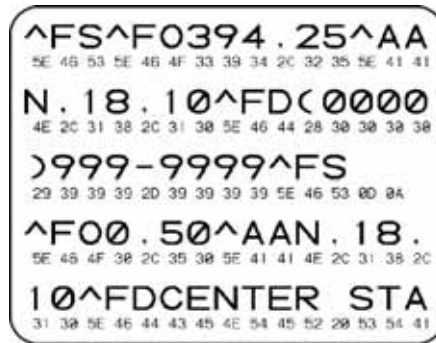
3. Release PAUSE/FEED.
A media sensor profile prints.

Communications Diagnostics Test

The communication diagnostics test is a troubleshooting tool for checking the interconnection between the printer and the host computer.

When the printer is in diagnostics mode, it prints all data received from the host computer as straight ASCII characters with the hex values below the ASCII text. The printer prints all characters received, including control codes such as CR (carriage return). [Figure 15](#) shows a typical printout from this test. The actual format is modified to print on narrow wristbands.

Figure 15 • Communications Diagnostics Test Printout



To use communications diagnostics mode, complete these steps:

1. Set the printer to Diagnostics mode by sending the ~JD ZPL II command to the printer. The printer enters Diagnostics mode and prints any data received from the host computer on a test printout



Note • The PAUSE/FEED button will not advance a wristband while the printer is in Diagnostics mode. Exit Diagnostics mode to use that button and feed a wristband.

2. Check the test printout for error codes. For any errors, check that your communication parameters are correct.

Errors show on the test printout as follows:

- FE indicates a framing error.
- OE indicates an overrun error.
- PE indicates a parity error.
- NE indicates noise.

3. Send the ~JE ZPL II command to the printer to return to normal operation.

Downloading Firmware

Zebra periodically issues updated firmware to enhance the usability of its printers. You may download the latest HC100 firmware to the printer at any time. For the latest firmware version and instructions for downloading it, go to <http://www.zebra.com/firmware>.



Note • Zebra Technologies is aware that some safety and compliance organizations require specific tested and approved firmware versions for the total system that uses the wristband printer. Applying older firmware versions to newer printers may disable some printer functions, such as networking.

Caution • During the firmware download process, the printer status indicator turns to a steady half-orange and half-green as the printer writes to flash memory.



Do NOT power cycle the printer during this phase. Doing so makes the printer inoperable.

If necessary, contact technical support for assistance (see [Contacts on page vii](#)).

You may choose to place the printer in forced download mode before downloading firmware. While in this mode, the printer does not accept wristband printing instructions or control panel button presses.

To place the printer in forced download mode, complete these steps:

1. Turn the printer off (O).
2. Press and hold PAUSE/FEED while turning on the printer (I).
During the printer self test, the printer status indicator rapidly alternates between yellow and orange for 3 seconds.



3. Release PAUSE/FEED during this light sequence to enter forced download mode.
The printer status indicator alternates between green and orange lights.



4. Download firmware to the printer using any available connection.
As firmware is downloading, a green light rotates on the printer status indicator.



During the firmware download process, the printer status indicator turns to a steady half-orange and half-green as the printer writes to flash memory. Do NOT power cycle the printer during this phase.



When the firmware download process is complete, the printer returns to normal operation. See [Media Status Indicator on page 20](#) for more information on the indicator lights.



Specifications

This section contains the specifications for the printer and wristbands.

Contents

Physical and Environmental	62
Printing	62
Standard and Optional Features	62
Power Cord	63

Physical and Environmental

Physical	
Dimensions (LxWxH)	9.5x5x7 in. (242x127x178 mm)
Clearance	6 in. (153 mm) above the printer to load a media cartridge
Weight	3.1 lb (1.4 kg)
Electrical	100-240 VAC, 50-60 Hz external power supply
Temperature	
Operating	40° to 104°F (5° to 40°C)
Storage	-40° to 140°F (-40° to 60°C)
Relative Humidity	
Operating	20% to 85%, non-condensing
Storage	5% to 85%, non-condensing

Printing

Printhead Resolution	300 dpi
Print Speed	2 in./sec (51 mm/sec) or 4 in./sec. (102mm/sec.) Note: Speed is set by the media cartridge.
Dot size (width x length)	0.0033 in. x 0.0039 in. (0.084 mm x 0.099 mm)
Minimum print length	3 in. (76 mm)
Maximum print length	22 in. (558 mm)
Bar code modulus (X) dimension	3.27 mil to 32.67 mil

Standard and Optional Features

Memory	<ul style="list-style-type: none"> Standard 8 MB Flash (2 MB user available) Optional 64 MB Flash (58 MB user available) Standard 16 MB SDRAM (4 MB user available)
Connectivity	<ul style="list-style-type: none"> RS-232 Serial USB 2.0 Optional 10/100 internal wired Ethernet (factory installed) Optional 802.11 b/g internal wireless Ethernet (factory installed)
Programming Languages	<ul style="list-style-type: none"> ZPL II XML Optional ZBI 2.0

Power Cord

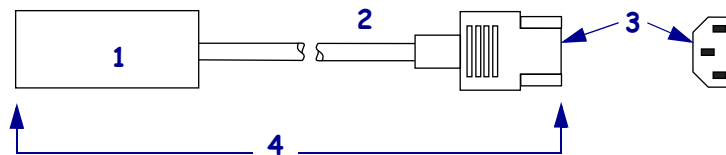


Caution • For personnel and equipment safety, always use an approved three-conductor power cord specific to the region or country intended for installation. This cord must use an IEC 320 female connector and the appropriate region-specific, three-conductor grounded plug configuration.

Depending on how your printer was ordered, a power cord may or may not be included. If one is not included or if the one included is not suitable for your requirements, see [Figure 16](#) and refer to the following guidelines:

- The overall cord length must be less than 9.8 ft. (3 m).
- The cord must be rated for at least 10 A, 250 V.
- The chassis ground (earth) **must** be connected to ensure safety and reduce electromagnetic interference.

Figure 16 • Power Cord Specifications



1	AC power plug for your country—This should bear the certification mark of at least one of the known international safety organizations (Figure 17).
2	3-conductor HAR cable or other cable approved for your country.
3	IEC 320 connector—This should bear the certification mark of at least one of the known international safety organizations (Figure 17).
4	Length ≤ 9.8 ft. (3 m). Rating 10 Amp, 250 VAC.

Figure 17 • International Safety Organization Certifications





Notes • _____
