



FR50 PEARL

Presentation Scanners

Disclaimer

© 2023 Newland Europe BV. All rights reserved.

Please read the manual carefully before using the product and operate it according to the manual. It is advised that you keep this manual for future reference.

Do not disassemble the device or remove the seal label from the device; doing so will void the product warranty provided by Newland Europe BV.

All pictures in this manual are for reference only, and the actual product may differ.

Regarding product modification and update, Newland Europe BV reserves the right to make changes to any software or hardware to improve reliability, function, or design at any time without notice. The information contained herein is subject to change without prior notice.

The products depicted in this manual may include software copyrighted by Newland Europe BV or a third party. The user, corporation or individual shall not duplicate, in whole or in part, distribute, modify, decompile, disassemble, decode, reverse engineer, rent, transfer, or sublicense such software without prior written consent from the copyright holders.

This manual is copyrighted. No part of this publication may be reproduced, distributed, or used in any form without Newland Europe BV's written permission.

Risk Warning Regarding Unauthorized System Updates:

You should use the Newland-provided tool to update this product's system. Modifying system files by installing a third-party ROM system or using any cracking method may result in product malfunction or data loss and void your warranty.

Newland Europe BV reserves the right to make a final interpretation of the statement above.

Newland Europe BV

Rolweg 25, 4104 AV, Culemborg,
The Netherlands
www.newland-id.com

Newland Europe BV is a subsidiary of Newland Digital Technology Co., Ltd. Our general conditions of Purchase, Sale and Delivery are filed with the Record Office of the Chamber of Commerce of Utrecht, The Netherlands.

K.v.K. H.R. Utrecht / Chamber of
Commerce Utrecht:
Reg. nr. 17109876

Revision History

Version	Description	Date
V1.0.0	Initial release.	Aug 6, 2020
V1.0.1	<ol style="list-style-type: none"><li data-bbox="318 497 669 527">1. Added black product picture.<li data-bbox="318 538 1243 687">2. Changed the default setting of Good Beep, Reread Timeout, Image Decoding Timeout, Image Change Trigger Sensitivity, USB HID Keyboard, interleaved 2 of 5, Matrix 2 of 5, PDF 417, Aztec, Data Matrix, Micro QR, Codabar, MSI-Plessey, GS1 Databar.	Sep 17, 2020

Table of Contents

Revision History	3
Preface	1
Introduction	1
Chapter Description	1
Explanation of Icons	2
Chapter 1 Getting Started	3
Introduction	3
Features of the FR50	3
Unpacking	3
FR50 Scanner Dimensions (unit: mm)	4
Front View	4
Side View	5
Bottom View	6
Connecting the FR50 to a Host	7
Using USB Cable	8
Using RS-232 Cable	9
Maintenance	10
Chapter 2 Easyset	11
Chapter 3 System Setting	12
Introduction	12
Barcode Programming	12
Programming Barcode/ Programming Command/Function	12
Use of Programming Barcodes	13
Illumination	14
Aiming	15
Good Read LED	15
Good Read LED Duration	16
Power On Beep	17
Good Read Beep	17
Good Read Beep Duration	18
Good Read Beep Frequency	19
Good Read Beep Volume	20
Scan Mode	21
Decode Session Timeout	22
Image Stabilization Timeout (Sense Mode)	23

Image Decoding Timeout	24
Reread Timeout	25
Trigger Selection (Sense Mode).....	26
Image Change Trigger Sensitivity	27
IR Proximity Trigger Sensitivity	28
Surround GS1 Application Identifiers (AI's) with Parentheses.....	29
Transmit GS1 Check Character	30
Trigger Commands	31
Modify Start Scanning Command	31
Modify Stop Scanning Command.....	32
Scanning Preference.....	33
Read Barcode On/Off.....	33
Decode Area	34
Image Flipping.....	38
Exposure Settings	39
Exposure Parameter Limit.....	39
Gain Parameter Limit	40
Bad Read Message.....	41
Set Bad Read Message	41
Default Settings.....	42
Factory Defaults	42
Custom Defaults	42
Query Product Information	43
Query Product Name	43
Query Firmware Version	43
Query Decoder Version.....	44
Query Hardware Version.....	44
Query Product Serial Number	44
Query Manufacturing Date	45
Query OEM Serial Number	45
Query Data Formatter Version	45
Chapter 4 RS-232.....	45
Introduction	45
Baud Rate	46
Parity Check.....	47
Data Bit	48
Stop Bit	48
Hardware Auto Flow Control	49
Chapter 5 USB Interface	50

Introduction	50
USB HID Keyboard	51
USB Country Keyboard Types	52
Beep on Unknown Character	56
Emulate ALT+Keypad	57
Code Page	58
Function Key Mapping	61
ASCII Function Key Mapping Table	62
ASCII Function Key Mapping Table (Continued)	63
Inter-Keystroke Delay	64
Caps Lock	65
Convert Case	66
Emulate Numeric Keypad	67
Fast Mode	69
Polling Rate	70
USB CDC	72
HID POS (POS HID Barcode Scanner)	73
Introduction	73
Access the Scanner with Your Program	73
Acquire Scanned Data	74
Send Command to the Scanner	74
IBM SurePOS (Tabletop)	75
IBM SurePOS (Handheld)	75
VID/PID	75
Chapter 6 Symbologies	76
Introduction	76
Global Settings	76
Enable/Disable All Symbologies	76
Enable/Disable 1D Symbologies	76
Enable/Disable 2D Symbologies	77
Enable/Disable Postal Symbologies	77
1D Twin Code	78
Code 128	79
Restore Factory Defaults	79
Enable/Disable Code 128	79
Set Length Range for Code 128	80
EAN-8	81
Restore Factory Defaults	81
Enable/Disable EAN-8	81

Transmit Check Character	81
2-Digit Add-On Code.....	82
5-Digit Add-On Code.....	83
Add-On Code Required.....	84
Convert EAN-8 to EAN-13	85
EAN-13	86
Restore Factory Defaults	86
Enable/Disable EAN-13.....	86
Transmit Check Character	87
2-Digit Add-On Code.....	87
5-Digit Add-On Code.....	88
Add-On Code Required.....	88
EAN-13 Beginning with 290 Add-On Code Required	89
EAN-13 Beginning with 378/379 Add-On Code Required	89
EAN-13 Beginning with 414/419 Add-On Code Required	90
EAN-13 Beginning with 434/439 Add-On Code Required	90
EAN-13 Beginning with 977 Add-On Code Required	91
EAN-13 Beginning with 978 Add-On Code Required	91
EAN-13 Beginning with 979 Add-On Code Required	92
UPC-E.....	93
Restore Factory Defaults	93
Enable/Disable UPC-E.....	93
UPC-E0.....	93
UPC-E1.....	94
Transmit Check Character	94
2-Digit Add-On Code.....	95
5-Digit Add-On Code.....	96
Transmit Preamble Character	97
Convert UPC-E to UPC-A	97
UPC-A.....	98
Restore Factory Defaults	98
Enable/Disable UPC-A.....	98
Transmit Check Character	98
2-Digit Add-On Code.....	99
5-Digit Add-On Code.....	100
Transmit Preamble Character	101
Coupon	102
UPC-A/EAN-13 with Extended Coupon Code	102
Coupon GS1 Databar Output.....	103

Interleaved 2 of 5	104
Restore Factory Defaults	104
Enable/Disable Interleaved 2 of 5	104
Set Length Range for Interleaved 2 of 5	105
Check Character Verification	106
Febraban.....	107
Disable/Enable Febraban.....	107
Transmit Delay per Character	107
Transmit Delay per 12 Characters	110
ITF-14	112
Restore Factory Defaults	112
Enable/Disable ITF-14	112
ITF-6	113
Restore Factory Defaults	113
Enable/Disable ITF-6	113
Matrix 2 of 5	114
Restore Factory Defaults	114
Enable/Disable Matrix 2 of 5	114
Set Length Range for Matrix 2 of 5	115
Check Character Verification	116
Code 39	117
Restore Factory Defaults	117
Enable/Disable Code 39	117
Set Length Range for Code 39	118
Check Character Verification	119
Transmit Start/Stop Character	120
Enable/Disable Code 39 Full ASCII	120
Enable/Disable Code 32 (Italian Pharma Code)	121
Code 32 Prefix	121
Transmit Code 32 Start/Stop Character	122
Transmit Code 32 Check Character.....	122
Codabar	123
Restore Factory Defaults	123
Enable/Disable Codabar	123
Set Length Range for Codabar	124
Check Character Verification	125
Start/Stop Character	126
Code 93	127
Restore Factory Defaults	127

Enable/Disable Code 93	127
Set Length Range for Code 93	128
Check Character Verification	129
China Post 25.....	130
Restore Factory Defaults	130
Enable/Disable China Post 25	130
Set Length Range for China Post 25	131
Check Character Verification	132
GS1-128 (UCC/EAN-128).....	132
Restore Factory Defaults	132
Enable/Disable GS1-128.....	132
Set Length Range for GS1-128.....	133
GS1 Databar (RSS)	134
Restore Factory Defaults	134
Enable/Disable GS1 Databar	134
Transmit Application Identifier "01"	134
GS1 Composite (EAN·UCC Composite).....	135
Restore Factory Defaults	135
Enable/Disable GS1 Composite.....	135
Enable/Disable UPC/EAN Composite	135
Code 11	136
Restore Factory Defaults	136
Enable/Disable Code 11	136
Set Length Range for Code 11	137
Check Character Verification	138
Transmit Check Character	139
ISBN.....	140
Restore Factory Defaults	140
Enable/Disable ISBN.....	140
Set ISBN Format.....	141
ISSN.....	142
Restore Factory Defaults	142
Enable/Disable ISSN.....	142
Industrial 25.....	143
Restore Factory Defaults	143
Enable/Disable Industrial 25	143
Set Length Range for Industrial 25	144
Check Character Verification	145
Standard 25.....	146

Restore Factory Defaults	146
Enable/Disable Standard 25	146
Set Length Range for Standard 25	147
Check Character Verification	148
Plessey	149
Restore Factory Defaults	149
Enable/Disable Plessey	149
Set Length Range for Plessey	150
Check Character Verification	151
MSI-Plessey	152
Restore Factory Defaults	152
Enable/Disable MSI-Plessey	152
Set Length Range for MSI-Plessey	153
Check Character Verification	154
Transmit Check Character	155
AIM 128	156
Restore Factory Defaults	156
Enable/Disable AIM 128	156
Set Length Range for AIM 128	157
ISBT 128	158
Restore Factory Defaults	158
Enable/Disable ISBT 128	158
Code 49	159
Restore Factory Defaults	159
Enable/Disable Code 49	159
Set Length Range for Code 49	160
Code 16K	162
Restore Factory Defaults	162
Enable/Disable Code 16K	162
Set Length Range for Code 16K	163
PDF417	164
Restore Factory Defaults	164
Enable/Disable PDF417	164
Set Length Range for PDF417	165
PDF417 Twin Code	166
PDF417 Inverse	167
Character Encoding	167
PDF417 ECI Output	168
Micro PDF417	169

Restore Factory Defaults	169
Enable/Disable Micro PDF417	169
Set Length Range for Micro PDF417	170
QR Code	171
Restore Factory Defaults	171
Enable/Disable QR Code	171
Set Length Range for QR Code	172
QR Twin Code	172
QR Inverse	173
Character Encoding	173
QR ECI Output	174
Micro QR Code	175
Restore Factory Defaults	175
Enable/Disable Micro QR	175
Set Length Range for Micro QR	176
Aztec	177
Restore Factory Defaults	177
Enable/Disable Aztec Code	177
Set Length Range for Aztec Code	178
Read Multi-barcodes on an Image	179
Set the Number of Barcodes	180
Character Encoding	181
Aztec ECI Output	181
Data Matrix	182
Restore Factory Defaults	182
Enable/Disable Data Matrix	182
Set Length Range for Data Matrix	183
Data Matrix Twin Code	184
Rectangular Barcode	185
Data Matrix Inverse	185
Character Encoding	186
Data Matrix ECI Output	186
Maxicode	187
Restore Factory Defaults	187
Enable/Disable Maxicode	187
Set Length Range for Maxicode	188
Chinese Sensible Code	189
Restore Factory Defaults	189
Enable/Disable Chinese Sensible Code	189

Set Length Range for Chinese Sensible Code.....	190
Chinese Sensible Twin Code	191
Chinese Sensible Code Inverse	192
GM Code.....	193
Restore Factory Defaults	193
Enable/Disable GM	193
Set Length Range for GM	194
Code One.....	195
Restore Factory Defaults	195
Enable/Disable Code One.....	195
Set Length Range for Code One.....	196
USPS Postnet	197
Restore Factory Defaults	197
Enable/Disable USPS Postnet	197
Transmit Check Character	197
USPS Intelligent Mail	198
Restore Factory Defaults	198
Enable/Disable USPS Intelligent Mail	198
Royal Mail	199
Restore Factory Defaults	199
Enable/Disable Royal Mail	199
USPS Planet	200
Restore Factory Defaults	200
Enable/Disable USPS Planet	200
Transmit Check Character	200
KIX Post.....	201
Restore Factory Defaults	201
Enable/Disable KIX Post.....	201
Australian Postal	202
Restore Factory Defaults	202
Enable/Disable Australian Postal	202
Japan Post	203
Restore Factory Defaults	203
Enable/Disable Japan Post.....	203
Passport OCR.....	204
Restore Factory Defaults	204
Enable/Disable Passport OCR.....	204
Chapter 7 Data Formatter	205
Introduction	205

Add a Data Format	205
Programming with Barcodes	205
Programming with Serial Commands	208
Enable/Disable Data Formatter	209
Non-Match Error Beep	210
Data Format Selection	211
Change Data Format for a Single Scan	212
Clear Data Format.....	213
Query Data Formats.....	213
Formatter Command Type 6	214
Send Commands	214
Move Commands	218
Search Commands	220
Comparison Command	223
Miscellaneous Commands	224
Chapter 8 Prefix & Suffix	233
Introduction	233
Global Settings.....	234
Enable/Disable All Prefixes/Suffixes	234
Prefix Sequence.....	234
Custom Prefix.....	231
Enable/Disable Custom Prefix	231
Set Custom Prefix	231
AIM ID Prefix	232
Code ID Prefix.....	233
Restore All Default Code IDs	233
Modify Code ID	233
Custom Suffix.....	242
Enable/Disable Custom Suffix	242
Set Custom Suffix	242
Data Packing.....	243
Introduction	243
Data Packing Options	243
Terminating Character Suffix.....	245
Enable/Disable Terminating Character Suffix.....	245
Set Terminating Character Suffix	245
Chapter 9 Batch Programming.....	247
Introduction	247
Create a Batch Command.....	248

Create a Batch Barcode	248
Use Batch Barcode	249
Appendix	250
Digit Barcodes	250
Save/Cancel Barcodes	253
Factory Defaults Table	254
AIM ID Table	263
Code ID Table	265
Symbology ID Number	267
ASCII Table.....	269
Unicode Key Maps	272

Preface

Introduction

This manual provides detailed instructions for setting up and using the NLS-FR50 desktop barcode scanner (hereinafter referred to as “**the FR50**” or “**the scanner**”).

Chapter Description

<i>Chapter 1 Getting Started</i>	: Gives a general description of FR50 scanner.
<i>Chapter 2 EasySet</i>	: Introduces a useful tool you can use to set up FR50 scanner and develop new applications.
<i>Chapter 3 System Settings</i>	: Introduces three configuration methods and describes how to configure general parameters of FR50 scanner.
<i>Chapter 4 RS-232 Interface</i>	: Describes how to configure RS-232 communication parameters.
<i>Chapter 5 USB Interface</i>	: Describes how to configure USB communication parameters.
<i>Chapter 6 Symbologies</i>	: Lists all compatible symbologies and describes how to configure the relevant parameters.
<i>Chapter 7 Data Formatter</i>	: Explains how to customize scanned data with the data formatter.
<i>Chapter 8 Prefix & Suffix</i>	: Describes how to use prefix and suffix to customize scanned data.
<i>Chapter 9 Batch Programming</i>	: Explains how to integrate a complex programming task into a single barcode.
<i>Appendix</i>	: Provides factory defaults table and a bunch of frequently used programming barcodes.

Explanation of Icons



This icon indicates something relevant to this manual.



This icon indicates this information requires extra attention from the reader.



This icon indicates handy tips that can help you use or configure the scanner with ease.



This icon indicates practical examples that can help you to acquaint yourself with operations.

Chapter 1 Getting Started

Introduction

The FR50 scanner reads a 1D or 2D barcode by capturing its image. Adopting the advanced **UING** technology independently developed by Newland Auto-ID Tech, it provides four scan modes, including Level Mode, Sense Mode, Continuous Mode and Pulse Mode, tailored to different scanning needs.

An illustrated introduction to the FR50 scanner is included in this chapter. If you have an FR50 scanner at hand, make good use of it to develop a better understanding of this manual. This chapter is written for normal users, maintenance staff and software developers.

Features of the FR50

- ★ Comprehensive data capture: 1D, 2D and postal barcodes.
- ★ Fast and accurate decoding capability: integrates high-performance processor and barcode decoder board.
- ★ Easy to configure and update.

Unpacking

Open the package and take out FR50 scanner and its accessories. Check to make sure everything on the packing list is present and intact. If any contents are damaged or missing, please keep the original package and contact your dealer immediately for after-sales service.

FR50 Scanner Dimensions (unit: mm)

Front View

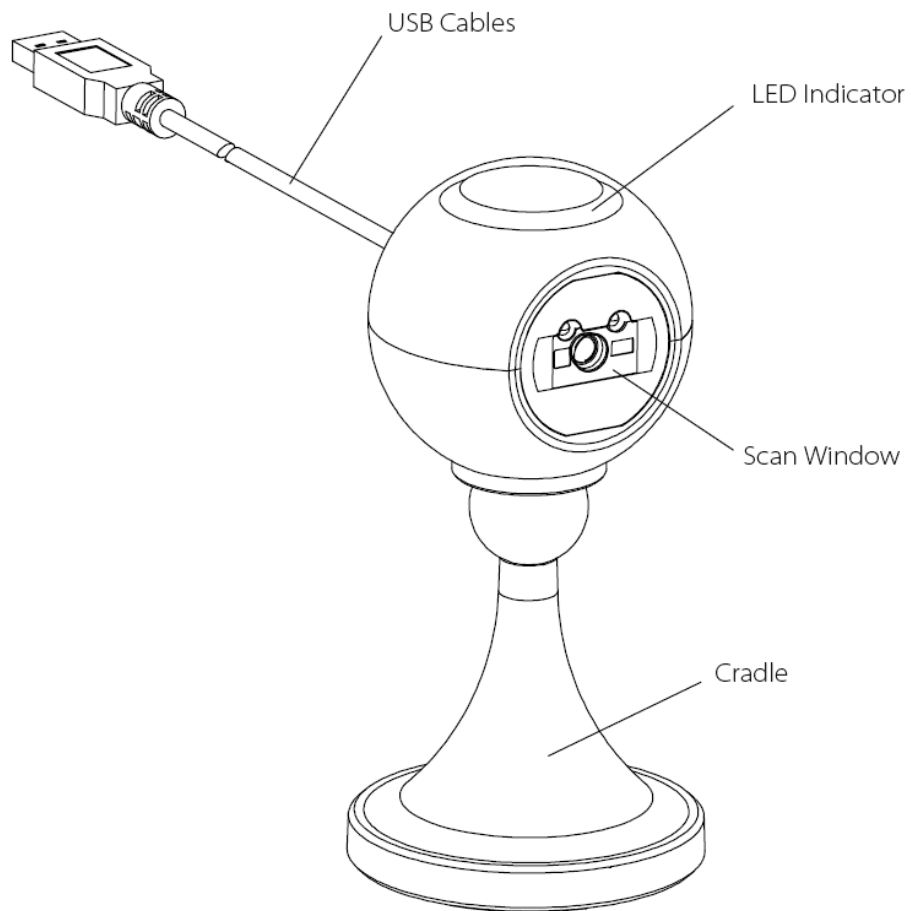

Side View

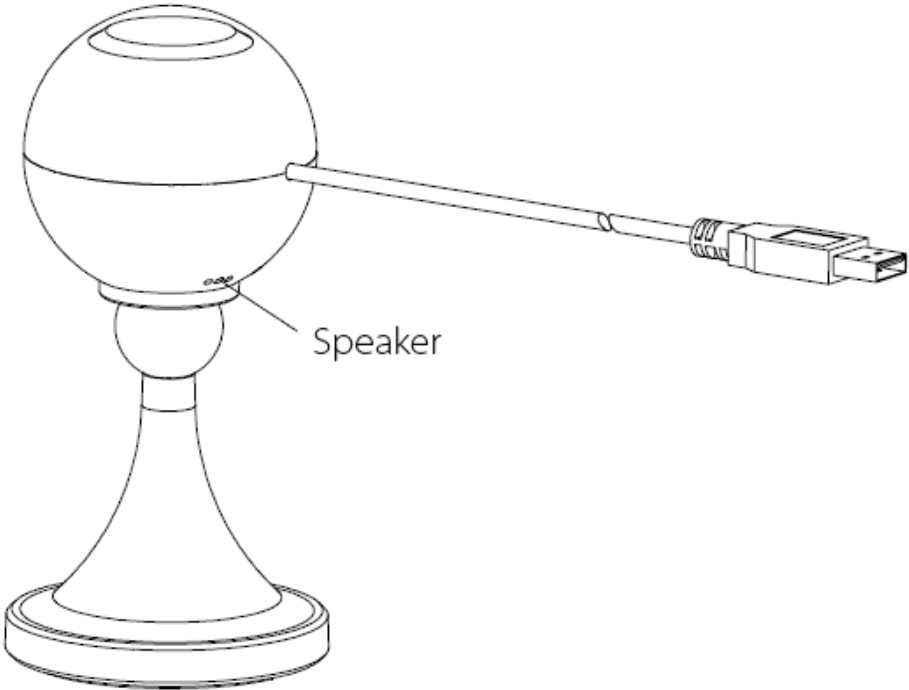

Bottom View

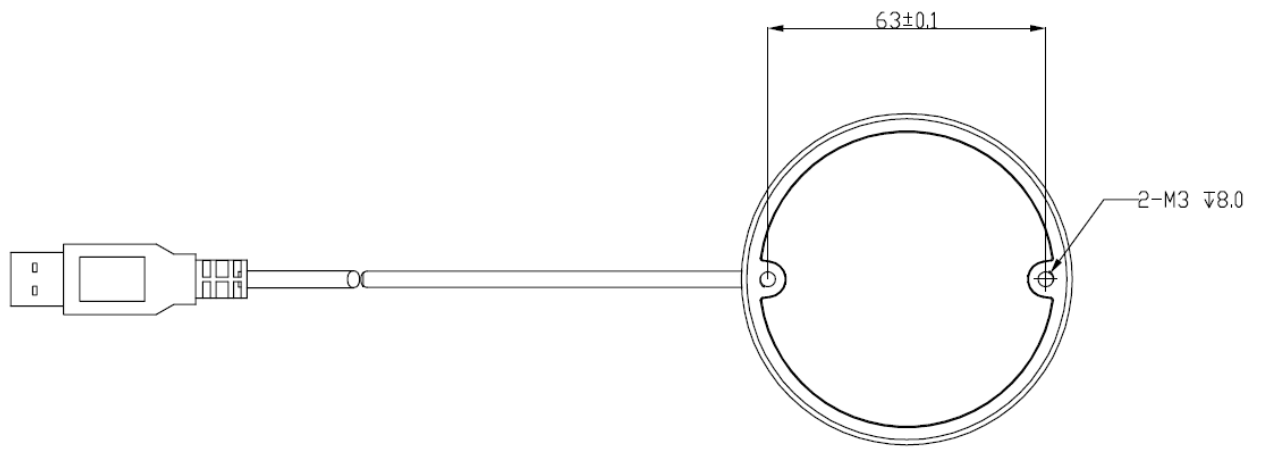

Connecting the FR50 to a Host

The scanner must be connected to a Host in actual application, such as PC, POS or any intelligent terminal USB port, using a communication cable

USB

USB port on the Host

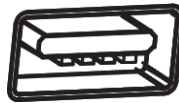



Maintenance

- ✧ The scan window should be kept clean.
- ✧ Do not scratch the scan window.
- ✧ Use soft brush to remove the stain from the scan window.
- ✧ Use the soft cloth to clean the window, such as eyeglass cleaning cloth.
- ✧ Do not spray any liquid on the scan window.
- ✧ Do not use the detergents except the water:



The warranty **DOES NOT** cover damages caused by inappropriate care and maintenance.

Chapter 2 Easyset

EasySet, developed by Fujian Newland Auto-ID Tech. Co., Ltd., is a configuration tool for Newland's 1D/2D barcode scanner, fixed mount barcode scanners and OEM scan engines. Its main features include:

- ✧ View device & configuration information of online device
- ✧ Configure device
- ✧ Update firmware of online device
- ✧ Load/modify existing XML configuration file; save current settings to an XML file
- ✧ Create/print/save programming barcodes to a PDF or Word file
- ✧ View/edit/save image stored on online device in the original image/BMP/JPG/TIFF format
- ✧ Send serial commands to online device and receive device response
- ✧ Supported languages: Chinese and English.

EasySet supports 32-bit/64-bit Microsoft WinXP/Win7/Win 8/Win 8.1/Win 10 operating systems.

EasySet can communicate with device via one of the following interface: RS-232, USB COM Port Emulation (UFCOM driver required), USB CDC (UFCOM driver required), USB DataPipe (UFCOM driver required), USB HID-POS.

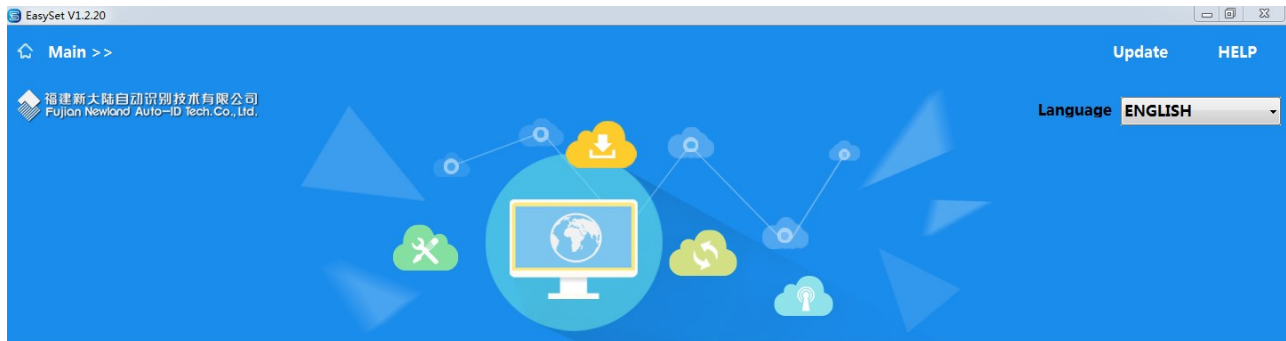

Online Device



Offline Device



Command Center



Batch update

Chapter 3 System Setting

Introduction

Barcode Programming

The FR50 can be configured by scanning programming barcodes. All user programmable features/options are described along with their programming barcodes/commands in the following sections.

This programming method is most straightforward. However, it requires manually scanning barcodes. As a result, errors are more likely to occur.

Programming Barcode/ Programming Command/Function



The figure above is an example that shows you the programming barcode and command for the Enter Setup function:

1. The **No Case Conversion** barcode.
2. The **No Case Conversion** command.
3. The description of feature/option.
4. ** indicates factory default settings.

Note: "@" included in the programming command indicates permanent setting which means the setting will not be lost by removing power from the scanner or turning off or rebooting it; whereas "#" included in the programming command indicates temporary setting which means the setting will be lost by removing power from the scanner or turning off or rebooting it.



@SETUPE1

Enter Setup

Use of Programming Barcodes

Scanning the **Enter Setup** barcode can enable the scanner to enter the setup mode. Then you can scan a number of programming barcodes to configure your scanner. To exit the setup mode, scan the **Exit Setup** barcode or a non-programming barcode, or reboot the scanner.



@SETUPE0

**** Exit Setup**



@SETUPE1

Enter Setup

Programming barcode data (i.e. the characters under programming barcode) can be transmitted to the host device. Scan the appropriate barcode below to enable or disable the transmission of programming barcode data to the host device.



@SETUPT0

**** Do Not Transmit Programming Barcode Data**



@SETUPT1

Transmit Programming Barcode Data



@SETUPE0

**** Exit Setup**



@SETUPE1

Enter Setup

Illumination



@ILLSCN1

**** On**



@ILLSCN0

Off



@ILLSCN2

Always On



@ILLSCN3

Fade Up



@SETUPE0

**** Exit Setup**



@SETUPE1

Enter Setup

Aiming

When scanning/capturing image, the scanner projects an aiming pattern which allows positioning the target barcode within its field of view and thus makes decoding easier.

Normal: The scanner projects an aiming pattern only during barcode scanning/capture.

Always On: Aiming pattern is constantly on after the scanner is powered on.

Off: Aiming pattern is off all the time.



@AMLENA1

** Normal



@AMLENA0

Off



@AMLENA2

Always On

Good Read LED

The green LED can be programmed to be On or Off to indicate good read.



@GRLENA1

** On



@GRLENA0

Off



@SETUPE0

** Exit Setup



@SETUPE1

Enter Setup

Good Read LED Duration

This parameter sets the amount of time that the Good Read LED to remain on following a good read. It is programmable in 1ms increments from 1ms to 2,500ms.



@GRLDUR20

**** Short (20ms)**



@GRLDUR120

Medium (120ms)



@GRLDUR220

Long (220ms)



@GRLDUR320

Prolonged (320ms)



@GRLDUR

Custom (1 - 2,500ms)

E
sample

Set the Good Read LED duration to 800ms:

1. Scan the **Enter Setup** barcode.
2. Scan the **Custom** barcode.
3. Scan the numeric barcodes "8", "0" and "0" from the "Digit Barcodes" section in Appendix.
4. Scan the **Save** barcode from the "Save/Cancel Barcodes" section in Appendix.
5. Scan the **Exit Setup** barcode.



@SETUPE0

**** Exit Setup**



@SETUPE1

Enter Setup

Power On Beep

The scanner can be programmed to beep when it is powered on. Scan the **Off** barcode if you do not want a power on beep.



@PWBENA1

**** On**



@PWBENA0

Off

Good Read Beep

Scanning the **Off** barcode can turn off the beep that indicates successful decode; scanning the **On** barcode can turn it back on.



@GRBENA1

**** On**



@GRBENA0

Off



@SETUPE0

**** Exit Setup**



@SETUPE1

Enter Setup

Good Read Beep Duration

This parameter sets the length of the beep the scanner emits on a good read. It is programmable in 1ms increments from 20ms to 300ms.



@GRBDUR40

Short (40ms)



@GRBDUR80

Medium (80ms)



@GRBDUR120

**** Long (120ms)**



@GRBDUR

Custom (20 – 300ms)

E
xample

Set the Good Read Beep duration to 200ms:

1. Scan the **Enter Setup** barcode.
2. Scan the **Custom** barcode.
3. Scan the numeric barcodes “2”, “0” and “0” from the “Digit Barcodes” section in Appendix.
4. Scan the **Save** barcode from the “Save/Cancel Barcodes” section in Appendix.
5. Scan the **Exit Setup** barcode.



@SETUPE0

**** Exit Setup**



@SETUPE1

Enter Setup

Good Read Beep Frequency

This parameter is programmable in 1Hz increments from 20Hz to 20,000Hz.



@GRBFRQ800

Extra Low (800Hz)



@GRBFRQ1600

Low (1600Hz)



@GRBFRQ2730

Medium (2730Hz)



@GRBFRQ4200

**** High (4200Hz)**



@GRBFRQ

Custom (20 - 20,000Hz)

E
sample

Set the Good Read Beep frequency to 2,000Hz:

1. Scan the **Enter Setup** barcode.
2. Scan the **Custom** barcode.
3. Scan the numeric barcodes “2”, “0”, “0” and “0” from the “Digit Barcodes” section in Appendix.
4. Scan the **Save** barcode from the “Save/Cancel Barcodes” section in Appendix.
5. Scan the **Exit Setup** barcode.



@SETUPE0

**** Exit Setup**



@SETUPE1

Enter Setup

Good Read Beep Volume

There are 20 volume levels to choose from. The bigger the value, the louder the Good Read Beep.



@GRBVLL20

**** Loud**



@GRBVLL8

Medium



@GRBVLL2

Low



@GRBVLL

Custom Volume (Level 1-20)

E
example

Set the Good Read Beep volume to 20:

1. Scan the **Enter Setup** barcode.
2. Scan the **Custom Volume** barcode.
3. Scan the numeric barcode "2" "0" from the "Digit Barcodes" section in Appendix.
4. Scan the **Save** barcode from the "Save/Cancel Barcodes" section in Appendix.
5. Scan the **Exit Setup** barcode.



@SETUPE0

**** Exit Setup**



@SETUPE1

Enter Setup

Scan Mode

Level Mode: A trigger pull activates a decode session. The decode session continues until a barcode is decoded or you release the trigger.

Sense Mode: The scanner activates a decode session every time it detects a barcode presented to it. The decode session continues until a barcode is decoded or the decode session timeout expires. **Timeout between Decodes (Same Barcode)** can avoid undesired rereading of same barcode in a given period of time. **Sensitivity** can change the Sense Mode's sensibility to changes in images captured. **Image Stabilization Timeout** gives the scanner time to adapt to ambient environment after it decodes a barcode and "looks" for another.

Continuous Mode: The scanner automatically starts one decode session after another. To suspend/resume barcode reading, simply press the trigger. **Timeout between Decodes (Same Barcode)** can avoid undesired rereading of same barcode in a given period of time.

Pulse Mode: When the trigger is pulled and released, scanning is activated until a barcode is decoded or the decode session timeout expires (The decode session timeout begins when the trigger is released).



@SCNMOD0

Level Mode



@SCNMOD2

**Sense Mode



@SCNMOD3

Continuous Mode



@SCNMOD4

Pulse Mode



@SETUPE0

** Exit Setup



@SETUPE1

Enter Setup

Decode Session Timeout

This parameter sets the maximum time decode session continues during a scan attempt. It is programmable in 1ms increments from 1ms to 3,600,000ms. When it is set to 0, the timeout is infinite. The default setting is 3,000ms.



@ORTSET

Decode Session Timeout

E
sample

Set the decode session timeout to 1,500ms:

1. Scan the **Enter Setup** barcode.
2. Scan the **Decode Session Timeout** barcode.
3. Scan the numeric barcodes “1”, “5”, “0” and “0” from the “Digit Barcodes” section in Appendix.
4. Scan the **Save** barcode from the “Save/Cancel Barcodes” section in Appendix.
5. Scan the **Exit Setup** barcode.



@SETUPE0

**** Exit Setup**



@SETUPE1

Enter Setup

Image Stabilization Timeout (Sense Mode)

This parameter defines the amount of time the scanner will spend adapting to ambient environment after it decodes a barcode and “looks” for another. It is programmable in 1ms increments from 0ms to 3,000ms. The default setting is 200ms.



@SENIST

Image Stabilization Timeout

E
xample

Set the image stabilization timeout to 800ms:

1. Scan the **Enter Setup** barcode.
2. Scan the **Image Stabilization Timeout** barcode.
3. Scan the numeric barcodes “8”, “0” and “0” from the “Digit Barcodes” section in Appendix.
4. Scan the **Save** barcode from the “Save/Cancel Barcodes” section in Appendix.
5. Scan the **Exit Setup** barcode.



@SETUPE0

**** Exit Setup**



@SETUPE1

Enter Setup

Image Decoding Timeout

Image Decoding Timeout specifies the maximum time the scanner will spend decoding an image. This parameter is programmable in 1ms increments from 1ms to 3,000ms. The default timeout is 3000ms.



@DETSET

Image Decoding Timeout

E
xample

Set the image decoding timeout to 1,000ms:

1. Scan the **Enter Setup** barcode.
2. Scan the **Image Decoding Timeout** barcode.
3. Scan the numeric barcodes “1”, “0”, “0” and “0” from the “Digit Barcodes” section in Appendix.
4. Scan the **Save** barcode from the “Save/Cancel Barcodes” section in Appendix.
5. Scan the **Exit Setup** barcode.



@SETUPE0

**** Exit Setup**



@SETUPE1

Enter Setup

Reread Timeout

Reread Timeout can avoid undesired rereading of same barcode in a given period of time. This feature is only applicable to the Sense and Continuous modes.

To enable/disable the Reread Timeout, scan the appropriate barcode below.

Enable Reread Timeout: Do not allow the scanner to re-read same barcode before the reread timeout expires.

Disable Reread Timeout: Allow the scanner to re-read same barcode.



@RRDENA1

Enable Reread Timeout



@RRDENA0

**** Disable Reread Timeout**

The following parameter sets the time interval between two successive reads on same barcode. It is programmable in 1ms increments from 0ms to 3,600,000ms. When it is set to a value greater than 3,000, the timeout for rereading same programming barcode is limited to 3,000ms. The default setting is 600ms.



@RRDDUR

Reread Timeout

Set the reread timeout to 1,000ms:

E
example

1. Scan the **Enter Setup** barcode.
2. Scan the **Reread Timeout** barcode.
3. Scan the numeric barcodes "1", "0", "0" and "0" from the "Digit Barcodes" section in Appendix.
4. Scan the **Save** barcode from the "Save/Cancel Barcodes" section in Appendix.
5. Scan the **Exit Setup** barcode.



@SETUPE0

**** Exit Setup**



@SETUPE1

Enter Setup

Trigger Selection (Sense Mode)



@SENTRG0

Image Change Trigger

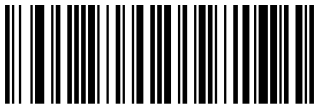

@SENTRG2

**** Both**



@SENTRG1

IR Proximity Trigger



@SETUPE0

**** Exit Setup**



@SETUPE1

Enter Setup

Image Change Trigger Sensitivity

This specifies the degree of acuteness of the scanner's response to changes in images captured. There are 20 levels to choose from. The smaller the value, the higher the sensitivity and the lower requirement in image change to trigger the scanner. You can select an appropriate degree of sensitivity that fits your application environment. This feature is only applicable to the Sense mode.



@SENLVL14

Low Sensitivity



@SENLVL11

Medium Sensitivity



@SENLVL8

**** High Sensitivity**



@SENLVL5

Enhanced Sensitivity



@SENLVL

Custom Sensitivity (Level 1-20)

E
sample

Set the image change trigger sensitivity to Level 10:

1. Scan the **Enter Setup** barcode.
2. Scan the **Custom Sensitivity** barcode.
3. Scan the numeric barcodes "1" and "0" from the "Digit Barcodes" section in Appendix.
4. Scan the **Save** barcode from the "Save/Cancel Barcodes" section in Appendix.
5. Scan the **Exit Setup** barcode.



@SETUPE0

**** Exit Setup**



@SETUPE1

Enter Setup

IR Proximity Trigger Sensitivity

This specifies the degree of acuteness of the scanner's "sense" to detect barcodes presented to it. There are 10 levels to choose from. The smaller the value, the higher the sensitivity and the further the scanner can reach. You can select an appropriate degree of sensitivity that fits your application needs. This feature is only applicable to the Sense mode.



@SENIRL9

Low Sensitivity



@SENIRL6

Medium Sensitivity



@SENIRL3

**** High Sensitivity**



@SENIRL

Custom Sensitivity (Level 1-10)

E
example

Set the IR proximity trigger sensitivity to Level 10:

1. Scan the **Enter Setup** barcode.
2. Scan the **Custom Sensitivity** barcode.
3. Scan the numeric barcodes "1" and "0" from the "Digit Barcodes" section in Appendix.
4. Scan the **Save** barcode from the "Save/Cancel Barcodes" section in Appendix.
5. Scan the **Exit Setup** barcode.



@SETUPE0

**** Exit Setup**



@SETUPE1

Enter Setup

Surround GS1 Application Identifiers (AI's) with Parentheses

When **Surround GS1 AI's with Parentheses** is selected, each application identifier (AI) contained in scanned data will be enclosed in parentheses in the output message.



@GS1AIP0

**** Do Not Surround GS1 AI's with Parentheses**



@GS1AIP1

Surround GS1 AI's with Parentheses

E
xample

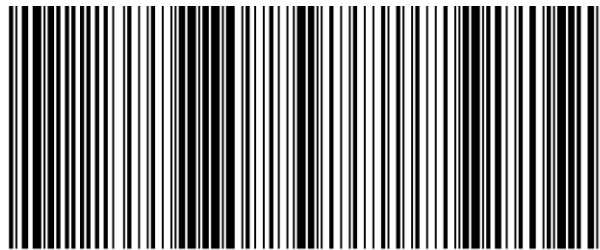

(01) 0 0614141 99999 6 (10) 10ABCEDF123456

If **Surround GS1 AI's with Parentheses** is selected, the barcode above is output as

(01)00614141999996(10)10ABCEDF123456.

If **Do Not Surround GS1 AI's with Parentheses** is selected, the barcode above is output as

01006141419999961010ABCEDF123456.



@SETUPE0

**** Exit Setup**



@SETUPE1

Enter Setup

Transmit GS1 Check Character



@GS1OCK0
Disable



@GS1OCK1
** Enable

E
xample

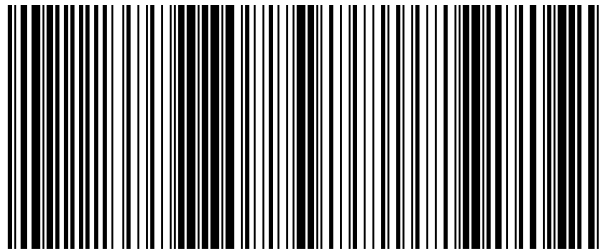

(01) 0 0614141 99999 6 (10) 10ABCEDF123456

If **Transmit GS1 Check Character** is Enabled, the barcode above is output as
01006141419999961010ABCEDF123456.

If **Transmit GS1 Check Character** is Disabled, the barcode above is output as
0100614141999991010ABCEDF123456.



@SETUPE0

** Exit Setup



@SETUPE1

Enter Setup

Trigger Commands

When **Enable Trigger Commands** is selected, you can activate and deactivate the scanner in the Level mode with serial trigger commands. Sending the **Start Scanning** command (default: **<SOH> T <EOT>**, user-programmable) to the scanner in the Level mode activates a decode session. The decode session continues until a barcode is decoded or the decode session timeout expires or the scanner receives the **Stop Scanning** command (default: **<SOH> P <EOT>**, user-programmable).



@SCNTCE0

**** Disable Trigger Commands**



@SCNTCE1

Enable Trigger Commands

Modify Start Scanning Command

The **Start Scanning** command can consist of 1-10 characters (HEX values from 0x01 to 0xFF). In this command, the character “?” (HEX: 0x3F) cannot be the first character. The default **Start Scanning** command is **<SOH> T <EOT>**.



@SCNTCT

Modify Start Scanning Command

E
sample

Set the Start Scanning command to “*T”:

1. Scan the **Enter Setup** barcode.
2. Scan the **Modify Start Scanning Command** barcode.
3. Scan the numeric barcodes “2”, “A”, “5” and “4” from the “Digit Barcodes” section in Appendix.
4. Scan the **Save** barcode from the “Save/Cancel Barcodes” section in Appendix.
5. Scan the **Exit Setup** barcode.



@SETUPE0

**** Exit Setup**



@SETUPE1

Enter Setup

Modify Stop Scanning Command

The **Stop Scanning** command can consist of 1-10 characters (HEX values from 0x01 to 0xFF). In this command, the character “?” (HEX: 0x3F) cannot be the first character. The default **Stop Scanning** command is **<SOH> P <EOT>**.



@SCNTCP

Modify Stop Scanning Command

E
xample

Set the Stop Scanning command to “*P”:

1. Scan the **Enter Setup** barcode.
2. Scan the **Modify Stop Scanning Command** barcode.
3. Scan the numeric barcodes “2”, “A”, “5” and “0” from the “Digit Barcodes” section in Appendix.
4. Scan the **Save** barcode from the “Save/Cancel Barcodes” section in Appendix.
5. Scan the **Exit Setup** barcode.



@SETUPE0

**** Exit Setup**



@SETUPE1

Enter Setup

Scanning Preference

Normal Mode: Select this mode when reading barcodes on paper.

Screen Mode: Select this mode when reading barcodes on the screen.



@EXPLVL0

**** Normal Mode**



@EXPLVL2

Screen Mode

Read Barcode On/Off

Sending the Read Barcode Off command `~<SOH>0000#SCNENA0;<ETX>` to the scanner can disable it from reading barcode, and the scanner is unable to scan barcode unless you send the Read Barcode On command `~<SOH>0000#SCNENA1;<ETX>` to it or power cycle it. By default, Read Barcode is On.



@SETUPE0

**** Exit Setup**



@SETUPE1

Enter Setup

Decode Area

Whole Area Decoding: The scanner attempts to decode barcode(s) within its field of view, from the center to the periphery, and transmits the barcode that has been first decoded.

Specific Area Decoding: The scanner attempts to read barcode(s) within a specified decoding area and transmits the barcode that has been first decoded. This option allows the scanner to narrow its field of view to make sure it reads only those barcodes intended by the user. For instance, if multiple barcodes are placed closely together, specific area decoding in conjunction with appropriate pre-defined decoding area will insure that only the desired barcode is read.



@CADENA0

**** Whole Area Decoding**



@CADENA1

Specific Area Decoding



@SETUPE0

**** Exit Setup**



@SETUPE1

Enter Setup

If **Specific Area Decoding** is enabled, the scanner only reads barcodes that intersect the predefined decoding area.

The default decoding area is an area of 40% top, 60% bottom, 40% left and 60% right of the scanner's field of view

You can define the decoding area using the **Top of Decoding Area**, **Bottom of Decoding Area**, **Left of Decoding Area** and **Right of Decoding Area** barcodes as well as numeric barcode(s) that represent(s) a desired percentage (0-100). The value of Bottom must be greater than that of Top; the value of Right must be greater than that of Left.



@CADTOP

Top of Decoding Area



@CADBOT

Bottom of Decoding Area



@CADLEF

Left of Decoding Area



@CADRIG

Right of Decoding Area



@SETUPE0

**** Exit Setup**



@SETUPE1
Enter Setup

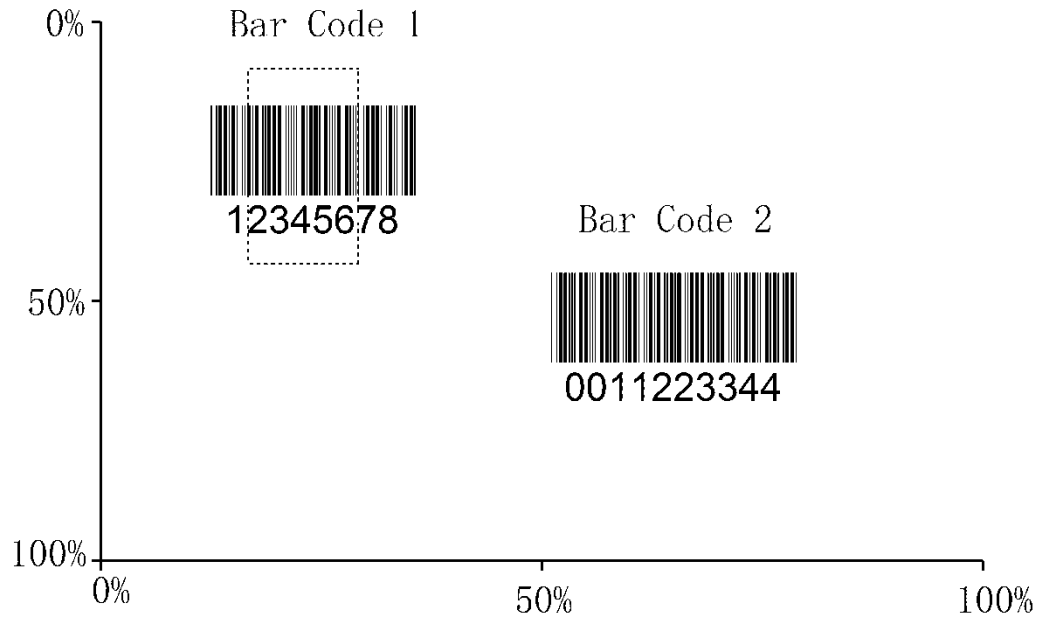

Example

Program the scanner to only read Barcode 1 in the figure above by setting the decoding area to 10% top, 45% bottom, 15% left and 30% right:

1. Scan the **Enter Setup** barcode.
2. Scan the **Top of Decoding Area** barcode.
3. Scan the numeric barcode "0" from the "Digit Barcodes" section in Appendix.
4. Scan the **Save** barcode from the "Save/Cancel Barcodes" section in Appendix.
5. Scan the **Bottom of Decoding Area** barcode.
6. Scan the numeric barcodes "4" and "5" from the "Digit Barcodes" section in Appendix.
7. Scan the **Save** barcode from the "Save/Cancel Barcodes" section in Appendix.
8. Scan the **Top of Decoding Area** barcode.
9. Scan the numeric barcodes "1" and "0" from the "Digit Barcodes" section in Appendix.
10. Scan the **Save** barcode from the "Save/Cancel Barcodes" section in Appendix.
11. Scan the **Left of Decoding Area** barcode.
12. Scan the numeric barcode "0" from the "Digit Barcodes" section in Appendix.
13. Scan the **Save** barcode from the "Save/Cancel Barcodes" section in Appendix.
14. Scan the **Right of Decoding Area** barcode.
15. Scan the numeric barcodes "3" and "0" from the "Digit Barcodes" section in Appendix.
16. Scan the **Save** barcode from the "Save/Cancel Barcodes" section in Appendix.



@SETUPE0
** Exit Setup



@SETUPE1

Enter Setup

17. Scan the **Left of Decoding Area** barcode.
18. Scan the numeric barcodes “1” and “5” from the “Digit Barcodes” section in Appendix.
19. Scan the **Save** barcode from the “Save/Cancel Barcodes” section in Appendix.
20. Scan the **Exit Setup** barcode.



@SETUPE0

**** Exit Setup**



@SETUPE1

Enter Setup

Image Flipping



@MIRROR0

** Do Not Flip



@MIRROR1

Flip Horizontally



@MIRROR2

Flip Vertically



@MIRROR3

Flip Horizontally & Vertically

Example of image not flipped



Example of image flipped horizontally



Example of image flipped vertically



Example of image flipped horizontally & vertically



@SETUPE0

** Exit Setup



@SETUPE1

Enter Setup

Exposure Settings

Exposure Parameter Limit

This feature defines the exposure parameter.

Off: the exposure time is set by the firmware.

On: the exposure time is ranged from the maximum exposure time and the minimum exposure time.

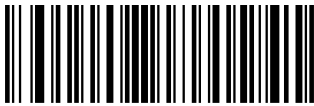

@EXPEEN0

** Off



@EXPEEN1

On

- ◆ **Setting the Maximum Exposure Time**



@EXPEMX

Maximum Exposure Time

- ◆ **Setting the Minimum Exposure Time**



@EXPEMN

Minimum Exposure Time



@SETUPE0

** Exit Setup



@SETUPE1

Enter Setup

Gain Parameter Limit

This feature defines the gain value.

Off: The gain value is defined by the firmware.

On: The gain value is ranged from the maximum gain value and the minimum gain value.



@EXPGEN0

**** Off**



@EXPGEN1

On

Setting the Maximum Gain Value



@EXPGMX

Maximum Gain Value

Setting the Minimum Gain Value



@EXPGMN

Minimum Gain Value



@SETUPE0

**** Exit Setup**



@SETUPE1

Enter Setup

Bad Read Message

Scan the appropriate barcode below to select whether or not to send a bad read message (user-programmable) when a good read does not occur before trigger release, or the decode session timeout expires, or the scanner receives the **Stop Scanning** command (For more information, see the “Serial Trigger Command” section in this chapter).



@NGRENA0

**** Bad Read Message OFF**



@NGRENA1

Bad Read Message ON

Set Bad Read Message

A bad read message can contain up to 7 characters (HEX values from 0x00 to 0xFF). To set a bad read message, scan the **Set Bad Read Message** barcode, the numeric barcodes representing the hexadecimal values of desired character(s) and the **Save** barcode. The default setting is “NG”.



@NGRSET

Set Bad Read Message

E
sample

Set the bad read message to “F” (HEX: 0x46):

1. Scan the **Enter Setup** barcode.
2. Scan the **Set Bad Read Message** barcode.
3. Scan the numeric barcodes “4” and “6” from the “Digit Barcodes” section in Appendix.
4. Scan the **Save** barcode from the “Save/Cancel Barcodes” section in Appendix.
5. Scan the **Exit Setup** barcode.



@SETUPE0

**** Exit Setup**



@SETUPE1

Enter Setup

Default Settings

Factory Defaults

Scanning the following barcode can restore the scanner to the factory defaults.

You may need to reset all parameters to the factory defaults when:

1. scanner is not properly configured so that it fails to decode barcodes.
2. you forget previous configuration and want to avoid its impact.



@FACDEF

Restore All Factory Defaults

Custom Defaults

Scanning the **Restore All Custom Defaults** barcode can reset all parameters to the custom defaults. Scanning the **Save as Custom Defaults** barcode can set the current settings as custom defaults.

Custom defaults are stored in the non-volatile memory.



@CUSSAV

Save as Custom Defaults



@CUSDEF

Restore All Custom Defaults



Restoring the scanner to the factory defaults will not remove the custom defaults from the scanner.



@SETUPE0

**** Exit Setup**



@SETUPE1

Enter Setup

Query Product Information

After scanning the barcode below, the product information (including product name, firmware version, decoder version, hardware version, product serial number, OEM serial number and manufacturing date) will be sent to the host device.



@QRYSYS

Query Product Information

Query Product Name



@QRYPDN

Query Product Name

Query Firmware Version



@QRYFWV

Query Firmware Version



@SETUPE0

**** Exit Setup**



@SETUPE1

Enter Setup

Query Decoder Version



@QRYDCV

Query Decoder Version

Query Hardware Version



@QRYHWW

Query Hardware Version

Query Product Serial Number



@QRYPSN

Query Product Serial Number



@SETUPE0

**** Exit Setup**



@SETUPE1

Enter Setup

Query Manufacturing Date



@QRYDAT

Query Manufacturing Date

Query OEM Serial Number



@QRYESN

Query OEM Serial Number

Query Data Formatter Version



@QRYDFM

Query Data Formatter Version



@SETUPE0

**** Exit Setup**

Chapter 4 RS-232

Introduction

When the scanner is connected to the RS-232 port of a host device, the scanner will automatically enable RS-232 communication. However, you need to set communication parameters (including baud rate, parity check, data bit and stop bit) on the scanner to match the host device so that two devices can communicate with each other.





@SETUPE1

Enter Setup

Baud Rate

Baud rate is the number of bits of data transmitted per second. Set the baud rate to match the host requirements.



@232BAD8

115200



@232BAD7

57600



@232BAD6

38400



@232BAD5

19200



@232BAD4

14400



@232BAD3

**** 9600**



@232BAD2

4800



@232BAD1

2400



@SETUPE0

**** Exit Setup**



Parity Check

Set the parity type to match the host requirements.

Odd Parity: If the data contains an odd number of 1 bits, the parity bit value is set to 0.

Even Parity: If the data contains an even number of 1 bits, the parity bit value is set to 0.

None: Select this option when no parity bit is required.



@232PAR0
**** None**



@232PAR1
Even Parity



@232PAR2
Odd Parity





@SETUPE1

Enter Setup

Data Bit

Set the number of data bits to match the host requirements.



@232DAT1

7 Data Bits



@232DAT0

**** 8 Data Bits**

Stop Bit

The stop bit(s) at the end of each transmitted character marks the end of transmission of one character and prepares the receiving device for the next character in the serial data stream. Set the number of stop bits to match the host requirements.



@232STP0

**** 1 Stop Bit**



@232STP1

2 Stop Bits



@SETUPE0

**** Exit Setup**



@SETUPE1

Enter Setup

Hardware Auto Flow Control

If this feature is enabled, the scanner determines whether to transmit data based on CTS signal level. When CTS signal is at a low level which means the serial port's cache memory of receiving device (such as PC) is full, the scanner sends data through RS-232 port until CTS signal is set to high level by receiving device. When the scanner is not ready for receiving, it will set RTS signal to low level. When sending device (such as PC) detects it, it will not send data to the scanner any more to prevent data loss.

If this feature is disabled, reception/transmission of serial data will not be influenced by RTS/CTS signal.



@232AFL0

**** Disable Hardware Auto Flow Control**



@232AFL1

Enable Hardware Auto Flow Control



Before enabling this feature, make sure that RTS/CTS signal lines are contained in RS-232 cable. Without the signal lines, RS-232 communication errors will occur.



@SETUPE0

**** Exit Setup**

Chapter 5 USB Interface

Introduction

There are four options for USB connection:

- ✧ USB HID Keyboard: The scanner's transmission is simulated as USB keyboard input with no need for command configuration or a driver. Barcode data could be entered by the virtual keyboard directly and it is also convenient for the host device to receive data.
- ✧ USB CDC: It is compliant with the standard USB CDC class specifications defined by the USB-IF and allows the host device to receive data in the way as a serial port does. A driver is needed when using this feature.
- ✧ HID POS (POS HID Barcode Scanner): It is based on the HID interface, with no need for a custom driver. It excels virtual keyboard and traditional RS-232 interface in transmission speed.
- ✧ IBM SurePOS: It conforms to IBM (now Toshiba Global Commerce Solutions) 4698 USB scanner interface specifications.

When the scanner is connected to both USB and RS-232 ports on a host device, it will select the USB connection by default.



@SETUPE1

Enter Setup

USB HID Keyboard

When the scanner is connected to the USB port on a host device, you can enable the USB HID Keyboard feature by scanning the barcode below. Then scanner's transmission will be simulated as USB keyboard input. The Host receives keystrokes on the virtual keyboard. It works on a Plug and Play basis and no driver is required.



@INTERF3

**** USB HID Keyboard**



If the host device allows keyboard input, then no extra software is needed for HID Keyboard input.



@SETUPE0

**** Exit Setup**



@SETUPE1

Enter Setup

USB Country Keyboard Types

Keyboard layouts vary from country to country. The default setting is U.S. keyboard.



@KBWCTY0

**** U.S. (English)**



@KBWCTY2

Brazil



@KBWCTY4

Czechoslovakia



@KBWCTY6

Finland (Swedish)



@KBWCTY1

Belgium



@KBWCTY3

Canada (French)



@KBWCTY5

Denmark



@SETUPE0

**** Exit Setup**



@SETUPE1

Enter Setup



@KBWCTY8

Germany/ Austria



@KBWCTY7

France



@KBWCTY9

Greece



@KBWCTY10

Hungary



@KBWCTY11

Israel (Hebrew)



@KBWCTY12

Italy



@KBWCTY13

Latin America/ South America



@KBWCTY14

Netherlands (Dutch)



@SETUPE0

**** Exit Setup**



@SETUPE1

Enter Setup



@KBWCTY16

Poland



@KBWCTY18

Romania

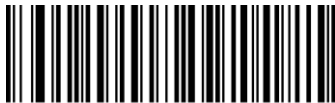

@KBWCTY21

Slovakia



@KBWCTY23

Sweden



@KBWCTY15

Norway



@KBWCTY17

Portugal



@KBWCTY19

Russia



@KBWCTY22

Spain



@SETUPE0

**** Exit Setup**



@SETUPE1

Enter Setup



@KBWCTY24

Switzerland (German)



@KBWCTY25

Turkey_F



@KBWCTY26

Turkey_Q



@KBWCTY27

UK



@KBWCTY28

Japan



@SETUPE0

**** Exit Setup**



Enter Setup

Beep on Unknown Character

Due to the differences in keyboard layouts, some characters contained in barcode data may be unavailable on the selected keyboard. As a result, the scanner fails to transmit the unknown characters.

Scan the appropriate barcode below to enable or disable the emission of beep when an unknown character is detected.



@KBWBUC0

**** Do Not Beep on Unknown Character**



@KBWBUC1

Beep on Unknown Character

Example

Supposing French keyboard (Country Code: 7) is selected and barcode data "ADF" is being dealt with, the keyboard will fail to locate the "Ð" (0xD0) character and the scanner will ignore the character and continue to process the next one.

Do Not Beep on Unknown Character: The scanner does not beep and the Host receives "AF".

Beep on Unknown Character: The scanner beeps and the Host still receives "AF".



If **Emulate ALT+Keypad ON** is selected, **Beep on Unknown Character** does not function.



**** Exit Setup**



@SETUPE1

Enter Setup

Emulate ALT+Keypad

When **Emulate ALT+Keypad** is turned on, any character whose ASCII value is greater than or equal to 0x20 is sent over the numeric keypad no matter which keyboard type is selected.

1. ALT Make
2. Enter the number corresponding to a desired character on the keypad.
3. ALT Break

After **Emulate ALT+Keypad ON** is selected, you need to choose the code page with which the barcodes were created and to turn **Unicode Encoding** On or Off depending on the encoding used by the application software.



@KBWALTO

** Emulate ALT+Keypad OFF



@KBWALT1

Emulate ALT+Keypad ON



Since sending a character involves multiple keystroke emulations, this method appears less efficient.

E *sample*

Supposing **Emulate ALT+Keypad** is ON, **Unicode Encoding** is Off, **Code Page 1252 (West European Latin)** is selected, and **Emulate Keypad with Leading Zero** is Off, barcode data "ADF" (65/208/70) is sent as below:

"A" -- "ALT Make" + "065" + "ALT Break"

"D" -- "ALT Make" + "208" + "ALT Break"

"F" -- "ALT Make" + "070" + "ALT Break"



@SETUPE0

** Exit Setup



@SETUPE1

Enter Setup

Code Page

Code pages define the mapping of character codes to characters. If the data received does not display with the proper characters, it may be because the barcode being scanned was created using a code page that is different from the one the host program is expecting. If this is the case, select the code page with which the barcodes were created by scanning the appropriate barcode below. For PDF417, QR Code, Aztec and Data Matrix, besides setting the code page, you also need to set the character encoding in the “Character Encoding” section in Chapter 6. This feature is only effective when **Emulate ALT+Keypad** is turned on.



@KBWCPG0

**** Code Page 1252 (West European Latin)**



@KBWCPG1

Code Page 1251 (Cyrillic)



@KBWCPG2

Code Page 1250 (Central and East European Latin)



@KBWCPG3

Code Page 1253 (Greek)



@KBWCPG4

Code Page 1254 (Turkish)



@KBWCPG5

Code Page 1255 (Hebrew)



@SETUPE0

**** Exit Setup**



@SETUPE1

Enter Setup



@KBWCPG6

Code Page 1256 (Arabic)



@KBWCPG7

Code Page 1257 (Baltic)



@KBWCPG8

Code Page 1258 (Vietnamese)



@KBWCPG9

Code Page 936 (Simplified Chinese, GB2312, GBK)



@KBWCPG10

Code Page 950 (Traditional Chinese, Big5)



@SETUPE0

**** Exit Setup**



@SETUPE1

Enter Setup

Unicode Encoding

Different host program may use different character encodings for handling incoming barcode data. For instance, Microsoft Office Word uses Unicode encoding and therefore you should turn **Unicode Encoding** on, whereas Microsoft Office Excel or Notepad uses Code Page encoding and therefore you should turn **Unicode Encoding** off. This feature is only effective when **Emulate ALT+Keypad** is turned on.



@KBWCPU0

**** Off**



@KBWCPU1

On

Emulate Keypad with Leading Zero

You may turn this feature on to send character sequences sent over the numeric keypad as ISO characters which have a leading zero. For example, ASCII A transmits as "ALT MAKE" 0065 "ALT BREAK". This feature is only effective when **Emulate ALT+Keypad** is enabled.



@KBWALZ1

**** On**



@KBWALZ0

Off



@SETUPE0

**** Exit Setup**



@SETUPE1

Enter Setup

Function Key Mapping

When **Ctrl+ASCII Mode** is selected, function characters (0x00 - 0x1F) are sent as ASCII sequences.



@KBWFKM0

** Disable



@KBWFKM1

Ctrl+ASCII Mode



@KBWFKM2

Alt+Keypad Mode

Example

If **Ctrl+ASCII Mode** is selected and other parameters of USB HID Keyboard adopt factory defaults, barcode data “A<HT>(i.e. Horizontal Tab)F” (0x41/0x09/0x46) is sent as below:

“A” - Keystroke “A”.

<HT> - “Ctrl Make” + Keystroke “I” + “Ctrl Break”

“F” - Keystroke “F”

For some text editors, “Ctrl I” means italic convert. So the output may be “AF”.

If **Alt+Keypad Mode** is selected and other parameters of USB HID Keyboard adopt factory defaults, the data above is sent as below:

“A” - Keystroke “A”.

<HT> - “Alt Make” + Keystrokes “009” + “Alt Break”

“F” - Keystroke “F”



@SETUPE0

** Exit Setup



@SETUPE1

Enter Setup

ASCII Function Key Mapping Table

ASCII Function	ASCII Value (HEX)	Function Key Mapping Disabled	Ctrl+ASCII
NUL	00	Null	Ctrl+@
SOH	01	Keypad Enter	Ctrl+A
STX	02	Caps Lock	Ctrl+B
ETX	03	ALT	Ctrl+C
EOT	04	Null	Ctrl+D
ENQ	05	CTRL	Ctrl+E
ACK	06	Null	Ctrl+F
BEL	07	Enter	Ctrl+G
BS	08	Left Arrow	Ctrl+H
HT	09	Horizontal Tab	Ctrl+I
LF	0A	Down Arrow	Ctrl+J
VT	0B	Vertical Tab	Ctrl+K
FF	0C	Delete	Ctrl+L
CR	0D	Enter	Ctrl+M
SO	0E	Insert	Ctrl+N
SI	0F	Esc	Ctrl+O
DLE	10	F11	Ctrl+P
DC1	11	Home	Ctrl+Q
DC2	12	PrintScreen	Ctrl+R
DC3	13	Backspace	Ctrl+S
DC4	14	tab+shift	Ctrl+T
NAK	15	F12	Ctrl+U
SYN	16	F1	Ctrl+V
ETB	17	F2	Ctrl+W
CAN	18	F3	Ctrl+X
EM	19	F4	Ctrl+Y
SUB	1A	F5	Ctrl+Z
ESC	11	F6	Ctrl+[
FS	1C	F7	Ctrl+\
GS	1D	F8	Ctrl+]
RS	1E	F9	Ctrl+6
US	1F	F10	Ctrl+-



@SETUPE0

** Exit Setup



@SETUPE1

Enter Setup

ASCII Function Key Mapping Table (Continued)

The last five characters (0x1B~0x1F) in the table above apply to US keyboard layout only. The following chart provides the equivalents of these five characters for other countries.

Country	Ctrl+ASCII					
United States	Ctrl+[Ctrl+\	Ctrl+]	Ctrl+6	Ctrl+-	
Belgium	Ctrl+[Ctrl+<	Ctrl+]	Ctrl+6	Ctrl+-	
Scandinavia	Ctrl+8	Ctrl+<	Ctrl+9	Ctrl+6	Ctrl+-	
France	Ctrl+^	Ctrl+8	Ctrl+\$	Ctrl+6	Ctrl+=	
Germany		Ctrl+Ã	Ctrl++	Ctrl+6	Ctrl+-	
Italy		Ctrl+\	Ctrl++	Ctrl+6	Ctrl+-	
Switzerland		Ctrl+<	Ctrl+..	Ctrl+6	Ctrl+-	
United Kingdom	Ctrl+[Ctrl+ ¢	Ctrl+]	Ctrl+6	Ctrl+-	
Denmark	Ctrl+8	Ctrl+\	Ctrl+9	Ctrl+6	Ctrl+-	
Norway	Ctrl+8	Ctrl+\	Ctrl+9	Ctrl+6	Ctrl+-	
Spain	Ctrl+[Ctrl+\	Ctrl+]	Ctrl+6	Ctrl+-	



@SETUPE0

** Exit Setup



@SETUPE1

Enter Setup

Inter-Keystroke Delay

This parameter specifies the delay between emulated keystrokes.



@KBWDLY0

**** No Delay**



@KBWDLY40

Long Delay (40ms)



@KBWDLY20

Short Delay (20ms)



@SETUPE0

**** Exit Setup**



@SETUPE1

Enter Setup

Caps Lock

The **Caps Lock On** options can invert upper and lower case characters contained in barcode data. This inversion occurs regardless of the state of Caps Lock key on the host device's keyboard. To disable this feature, scan the appropriate **Caps Lock OFF** barcode below based on your keyboard.



@KBWCAP0

** Caps Lock OFF, Non-Japanese Keyboard



@KBWCAP1

Caps Lock ON, Non-Japanese Keyboard



Emulate ALT+Keypad ON/ Convert All to Upper Case/ Convert All to Lower Case prevails over Caps Lock ON.

E
xample

When the **Caps Lock ON** feature is selected, barcode data "AbC" is transmitted as "aBc".



@SETUPE0

** Exit Setup



@SETUPE1

Enter Setup

Convert Case

Scan the appropriate barcode below to convert all bar code data to your desired case.



@KBWCAS0

**** No Case Conversion**



@KBWCAS1

Convert All to Upper Case



@KBWCAS2

Convert All to Lower Case

E
xample

When the **Convert All to Lower Case** feature is enabled, barcode data "AbC" is transmitted as "abc".



If **Emulate ALT+Keypad ON** is selected, **Convert All to Lower Case** and **Convert All to Upper Case** do not function.



@SETUPE0

**** Exit Setup**



@SETUPE1

Enter Setup

Emulate Numeric Keypad



Do Not Emulate Numeric Keypad 1: Sending a number (0-9) is emulated as keystroke(s) on main keyboard.

Emulate Numeric Keypad 1: Sending a number (0-9) is emulated as keystroke(s) on numeric keypad. The state of Num Lock on the simulated numeric keypad is determined by its equivalent on the host device. If Num Lock on the host device is turned off, the output of simulated numeric keypad is function key instead of number.

Do Not Emulate Numeric Keypad 2: Sending “+”, “-”, “*” and “/” is emulated as keystroke(s) on main keyboard.

Emulate Numeric Keypad 2: Sending “+”, “-”, “*” and “/” is emulated as keystroke(s) on numeric keypad.



@KBWNUM0

**** Do Not Emulate Numeric Keypad 1**



@KBWNUM1

Emulate Numeric Keypad 1



@SETUPE0

**** Exit Setup**



@SETUPE1

Enter Setup



@KBWNCH0

**** Do Not Emulate Numeric Keypad 2**



@KBWNCH1

Emulate Numeric Keypad 2



Emulate ALT+Keypad ON prevails over **Emulate Numeric Keypad**.

E
sample

Supposing the **Emulate Numeric Keypad 1** feature is enabled:

if Num Lock on the host device is ON, "A4.5" is transmitted as "A4.5";

if Num Lock on the host device is OFF, "A4.5" is transmitted as ".A":

1. "A" is sent on main keyboard;
2. "4" is sent as the function key "Cursor Move to Left";
3. "." is sent on main keyboard;
4. "5" is not sent as it does not correspond to any function key.



@SETUPE0

**** Exit Setup**



@SETUPE1

Enter Setup

Fast Mode

When **Fast Mode On** is selected, the scanner sends characters to the Host faster. If the Host drops characters, turn the Fast Mode off or change the polling rate to a bigger value.



@KBWFAS0

**** Fast Mode Off**



@KBWFAS1

Fast Mode On



@SETUPE0

**** Exit Setup**



@SETUPE1

Enter Setup

Polling Rate

This parameter specifies the polling rate for a USB keyboard. If the Host drops characters, change the polling rate to a bigger value.



@KBWPOR0

1ms



@KBWPOR1

2ms



@KBWPOR2

3ms



@KBWPOR3

**** 4ms**



@KBWPOR4

5ms



@KBWPOR5

6ms



@KBWPOR6

7ms



@SETUPE0

**** Exit Setup**



@SETUPE1

Enter Setup



@KBWPOR7

8ms



@KBWPOR8

9ms



@KBWPOR9

10ms



@SETUPE0

**** Exit Setup**



@SETUPE1

Enter Setup

USB CDC

If your scanner is connected to the USB port on a host device, the USB CDC feature allows the host device to receive data in the way as a serial port does. A driver is needed when using this feature. You may download it from our website at www.newlandaidc.com.



@INTERF8

USB CDC



@SETUPE0

**** Exit Setup**



@SETUPE1

Enter Setup

HID POS (POS HID Barcode Scanner)

Introduction

The HID-POS interface is recommended for new application programs. It can send up to 56 characters in a single USB report and appears more efficient than keyboard emulation.

Features:

1. HID based, no custom driver required.
2. Way more efficient in communication than keyboard emulation and traditional RS-232 interface.



@INTERF5

USB HID-POS

Access the Scanner with Your Program

Use CreateFile to access the scanner as a HID device and then use ReadFile to deliver the scanned data to the application program. Use WriteFile to send data to the scanner.

For detailed information about USB and HID interfaces, go to www.USB.org.



@SETUPE0

**** Exit Setup**



@SETUPE1

Enter Setup

Acquire Scanned Data

After a barcode is decoded, the scanner sends an input report as below:

	Bit							
Byte	7	6	5	4	3	2	1	0
0	Report ID = 0x02							
1	Barcode Length							
2-57	Decoded Data (1-56)							
58-61	Reserved							
62	Newland Symbology Identifier or N/C: 0x00							
63	-	-	-	-	-	-	-	Decoded data continued

Send Command to the Scanner

This output report is used to send commands to the scanner. All programming commands can be used.

	Bit							
Byte	7	6	5	4	3	2	1	0
0	Report ID = 0x04							
1	Length of command							
2-63	Command (1-62)							



@SETUPE0

** Exit Setup



@SETUPE1

Enter Setup

IBM SurePOS (Tabletop)



@INTERF6

IBM SurePOS (Tabletop)

IBM SurePOS (Handheld)



@INTERF7

IBM SurePOS (Handheld)

VID/PID

USB uses VID (Vendor ID) and PID (Product ID) to identify and locate a device. The VID is assigned by USB Implementers Forum. Newland's vendor ID is 1EAB (Hex). A range of PIDs are used for each Newland product family. Every PID contains a base number and interface type (keyboard, COM port, etc.).

Product	Interface	PID (Hex)	PID (Dec)
FR50	USB HID Keyboard	0022	0034
	USB CDC	0006	0006
	HID POS	0010	0016
	IBM SurePOS (Tabletop)	0020	0032
	IBM SurePOS(Handheld)	0021	0033



@SETUPE0

** Exit Setup

Chapter 6 Symbologies

Introduction

Every symbology (barcode type) has its own unique attributes. This chapter provides programming barcodes for configuring the scanner so that it can identify various symbologies. It is recommended to disable those that are rarely used to increase the efficiency of the scanner.

Global Settings

Enable/Disable All Symbologies

If the **Disable All Symbologies** feature is enabled, the scanner will not be able to read any non-programming barcodes except the programming barcodes.



@ALLENA1

Enable All Symbologies



@ALLENA0

Disable All Symbologies

Enable/Disable 1D Symbologies



@ALL1DC1

Enable 1D Symbologies



@ALL1DC0

Disable 1D Symbologies



@SETUPE1

Enter Setup

Enable/Disable 2D Symbologies



@ALL2DC1

Enable 2D Symbologies



@ALL2DC0

Disable 2D Symbologies

Enable/Disable Postal Symbologies



@ALLPST1

Enable All Postal Symbologies



@ALLPST0

Disable All Postal Symbologies



@SETUPE0

**** Exit Setup**



@SETUPE1

Enter Setup

1D Twin Code

1D twin code is two 1D barcodes of a symbology or of different symbologies paralleled vertically. Both barcodes must have similar specifications and be placed closely together.

There are 3 options for reading 1D twin code:

- ❖ **Single 1D Code Only:** Read either 1D code.
- ❖ **Twin 1D Code Only:** Read both 1D codes. Transmission sequence: upper 1D code followed by lower 1D code.
- ❖ **Both Single & Twin:** Read both 1D codes. If successful, transmit as twin 1D code only. Otherwise, try single 1D code only.



@A1DDOU0

**** Single 1D Code Only**



@A1DDOU2

Twin 1D Code Only



@A1DDOU1

Both Single & Twin



@SETUPE0

**** Exit Setup**



@SETUPE1

Enter Setup

Code 128

Restore Factory Defaults



@128DEF

Restore the Factory Defaults of Code 128

Enable/Disable Code 128



@128ENA1

**** Enable Code 128**



@128ENA0

Disable Code 128



If the scanner fails to identify Code 128 barcodes, you may first try this solution by scanning the **Enter Setup** barcode and then **Enable Code 128** barcode.



@SETUPE0

**** Exit Setup**



@SETUPE1

Enter Setup

Set Length Range for Code 128

The scanner can be configured to only decode Code 128 barcodes with lengths that fall between (inclusive) the minimum and maximum lengths. To accomplish it, you need to set the minimum and maximum lengths.



@128MIN

Set the Minimum Length (Default: 1)



@128MAX

Set the Maximum Length (Default: 48)



If minimum length is set to be greater than maximum length, the scanner only decodes Code 128 barcodes with either the minimum or maximum length. If minimum length is same as maximum length, only Code 128 barcodes with that length are to be decoded.

E *xample*

Set the scanner to decode Code 128 barcodes containing between 8 and 12 characters:

1. Scan the **Enter Setup** barcode.
2. Scan the **Set the Minimum Length** barcode.
3. Scan the numeric barcode “8” from the “Digit Barcodes” section in Appendix.
4. Scan the **Save** barcode from the “Save/Cancel Barcodes” section in Appendix.
5. Scan the **Set the Maximum Length** barcode.
6. Scan the numeric barcodes “1” and “2” from the “Digit Barcodes” section in Appendix.
7. Scan the **Save** barcode from the “Save/Cancel Barcodes” section in Appendix.
8. Scan the **Exit Setup** barcode.



@SETUPE0

**** Exit Setup**



@SETUPE1

Enter Setup

EAN-8

Restore Factory Defaults



@EA8DEF

Restore the Factory Defaults of EAN-8

Enable/Disable EAN-8



@EA8ENA1

** Enable EAN-8



@EA8ENA0

Disable EAN-8



If the scanner fails to identify EAN-8 barcodes, you may first try this solution by scanning the **Enter Setup** barcode and then **Enable EAN-8** barcode.

Transmit Check Character

EAN-8 is 8 digits in length with the last one as its check character used to verify the integrity of the data.



@EA8CHK2

** Transmit EAN-8 Check Character



@EA8CHK1

Do Not Transmit EAN-8 Check Character



@SETUPE0

** Exit Setup



Enter Setup

2-Digit Add-On Code

An EAN-8 barcode can be augmented with a two-digit add-on code to form a new one. In the example below, the part surrounded by blue dotted line is an EAN-8 barcode while the part circled by red dotted line is a two-digit add-on code.



**** Disable 2-Digit Add-On Code**



Enable 2-Digit Add-On Code



Disable 2-Digit Add-On Code: The scanner decodes EAN-8 and ignores the add-on code when presented with an EAN-8 plus 2-digit add-on barcode. It can also decode EAN-8 barcodes without 2-digit add-on codes.

Enable 2-Digit Add-On Code: The scanner decodes a mix of EAN-8 barcodes with and without 2-digit add-on codes.



**** Exit Setup**



@SETUPE1

Enter Setup

5-Digit Add-On Code

An EAN-8 barcode can be augmented with a five-digit add-on code to form a new one. In the example below, the part surrounded by blue dotted line is an EAN-8 barcode while the part circled by red dotted line is a five-digit add-on code.



@EA8AD50

**** Disable 5-Digit Add-On Code**



@EA8AD51

Enable 5-Digit Add-On Code



Disable 5-Digit Add-On Code: The scanner decodes EAN-8 and ignores the add-on code when presented with an EAN-8 plus 5-digit add-on barcode. It can also decode EAN-8 barcodes without 5-digit add-on codes.

Enable 5-Digit Add-On Code: The scanner decodes a mix of EAN-8 barcodes with and without 5-digit add-on codes.



@SETUPE0

**** Exit Setup**



@SETUPE1

Enter Setup

Add-On Code Required

When **EAN-8 Add-On Code Required** is selected, the scanner will only read EAN-8 barcodes that contain add-on codes.



@EA8REQ0

**** EAN-8 Add-On Code Not Required**



@EA8REQ1

EAN-8 Add-On Code Required



@SETUPE0

**** Exit Setup**



@SETUPE1

Enter Setup

Convert EAN-8 to EAN-13

Convert EAN-8 to EAN-13: Convert EAN-8 decoded data to EAN-13 format before transmission. After conversion, the data follows EAN-13 format and is affected by EAN-13 programming selections (e.g., Check Character).

Do Not Convert EAN-8 to EAN-13: EAN-8 decoded data is transmitted as EAN-8 data, without conversion.



@EA8EXP0

**** Do Not Convert EAN-8 to EAN-13**



@EA8EXP1

Convert EAN-8 to EAN-13



@SETUPE0

**** Exit Setup**



@SETUPE1

Enter Setup

EAN-13

Restore Factory Defaults



@E13DEF

Restore the Factory Defaults of EAN-13

Enable/Disable EAN-13



@E13ENA1

**** Enable EAN-13**



@E13ENA0

Disable EAN-13



If the scanner fails to identify EAN-13 barcodes, you may first try this solution by scanning the **Enter Setup** barcode and then **Enable EAN-13** barcode.



@SETUPE0

**** Exit Setup**



@SETUPE1

Enter Setup

Transmit Check Character



@E13CHK2

**** Transmit EAN-13 Check Character**



@E13CHK1

Do Not Transmit EAN-13 Check Character

2-Digit Add-On Code

An EAN-13 barcode can be augmented with a two-digit add-on code to form a new one. In the example below, the part surrounded by blue dotted line is an EAN-13 barcode while the part circled by red dotted line is a two-digit add-on code.



@E13AD20

**** Disable 2-Digit Add-On Code**



@E13AD21

Enable 2-Digit Add-On Code



Disable 2-Digit Add-On Code: The scanner decodes EAN-13 and ignores the add-on code when presented with an EAN-13 plus 2-digit add-on barcode. It can also decode EAN-13 barcodes without 2-digit add-on codes.

Enable 2-Digit Add-On Code: The scanner decodes a mix of EAN-13 barcodes with and without 2-digit add-on codes.



@SETUPE0

**** Exit Setup**



@SETUPE1

Enter Setup

5-Digit Add-On Code

An EAN-13 barcode can be augmented with a five-digit add-on code to form a new one. In the example below, the part surrounded by blue dotted line is an EAN-13 barcode while the part circled by red dotted line is a five-digit add-on code.



@E13AD50

**** Disable 5-Digit Add-On Code**



@E13AD51

Enable 5-Digit Add-On Code



Disable 5-Digit Add-On Code: The scanner decodes EAN-13 and ignores the add-on code when presented with an EAN-13 plus 5-digit add-on barcode. It can also decode EAN-13 barcodes without 5-digit add-on codes.

Enable 5-Digit Add-On Code: The scanner decodes a mix of EAN-13 barcodes with and without 5-digit add-on codes.

Add-On Code Required

When **EAN-13 Add-On Code Required** is selected, the scanner will only read EAN-13 barcodes that contain add-on codes.



@E13REQ0

**** EAN-13 Add-On Code Not Required**



@E13REQ1

EAN-13 Add-On Code Required



@SETUPE0

**** Exit Setup**



@SETUPE1

Enter Setup

EAN-13 Beginning with 290 Add-On Code Required

This setting programs the scanner to require an add-on code (2-digit or 5-digit) on EAN-13 barcodes that begin with “290”. The following settings can be programmed:

Require Add-On Code: All EAN-13 barcodes that begin with “290” must have a 2-digit or 5-digit add-on code. The EAN-13 barcode with the add-on code is then transmitted. If the required add-on code is not found, the EAN-13 barcode is discarded.

Do Not Require Add-On Code: If you have selected **Require Add-On Code**, and you want to disable this feature, scan **Do Not Require Add-On Code**. EAN-13 barcodes are handled, depending on your selection for the “Add-On Code Required” feature.



@E132900

**** Do Not Require Add-On Code**



@E132901

Require Add-On Code

EAN-13 Beginning with 378/379 Add-On Code Required

This setting programs the scanner to require an add-on code (2-digit or 5-digit) on EAN-13 barcodes that begin with a “378” or “379”. The following settings can be programmed:

Require Add-On Code: All EAN-13 barcodes that begin with a “378” or “379” must have a 2-digit or 5-digit add-on code. The EAN-13 barcode with the add-on code is then transmitted. If the required add-on code is not found, the EAN-13 barcode is discarded.

Do Not Require Add-On Code: If you have selected **Require Add-On Code**, and you want to disable this feature, scan **Do Not Require Add-On Code**. EAN-13 barcodes are handled, depending on your selection for the “Add-On Code Required” feature.



@E133780

**** Do Not Require Add-On Code**



@E133781

Require Add-On Code



@SETUPE0

**** Exit Setup**



Enter Setup

EAN-13 Beginning with 414/419 Add-On Code Required

This setting programs the scanner to require an add-on code (2-digit or 5-digit) on EAN-13 barcodes that begin with a “414” or “419”. The following settings can be programmed:

Require Add-On Code: All EAN-13 barcodes that begin with a “414” or “419” must have a 2-digit or 5-digit add-on code. The EAN-13 barcode with the add-on code is then transmitted. If the required add-on code is not found, the EAN-13 barcode is discarded.

Do Not Require Add-On Code: If you have selected **Require Add-On Code**, and you want to disable this feature, scan **Do Not Require Add-On Code**. EAN-13 barcodes are handled, depending on your selection for the “Add-On Code Required” feature.



**** Do Not Require Add-On Code**



Require Add-On Code

EAN-13 Beginning with 434/439 Add-On Code Required

This setting programs the scanner to require an add-on code (2-digit or 5-digit) on EAN-13 barcodes that begin with a “434” or “439”. The following settings can be programmed:

Require Add-On Code: All EAN-13 barcodes that begin with a “434” or “439” must have a 2-digit or 5-digit add-on code. The EAN-13 barcode with the add-on code is then transmitted. If the required add-on code is not found, the EAN-13 barcode is discarded.

Do Not Require Add-On Code: If you have selected **Require Add-On Code**, and you want to disable this feature, scan **Do Not Require Add-On Code**. EAN-13 barcodes are handled, depending on your selection for the “Add-On Code Required” feature.



**** Do Not Require Add-On Code**



Require Add-On Code



**** Exit Setup**



@SETUPE1

Enter Setup

EAN-13 Beginning with 977 Add-On Code Required

This setting programs the scanner to require an add-on code (2-digit or 5-digit) on EAN-13 barcodes that begin with “977”. The following settings can be programmed:

Require Add-On Code: All EAN-13 barcodes that begin with “977” must have a 2-digit or 5-digit add-on code. The EAN-13 barcode with the add-on code is then transmitted. If the required add-on code is not found, the EAN-13 barcode is discarded.

Do Not Require Add-On Code: If you have selected **Require Add-On Code**, and you want to disable this feature, scan **Do Not Require Add-On Code**. EAN-13 barcodes are handled, depending on your selection for the “Add-On Code Required” feature.



@E139770

**** Do Not Require Add-On Code**



@E139771

Require Add-On Code

EAN-13 Beginning with 978 Add-On Code Required

This setting programs the scanner to require an add-on code (2-digit or 5-digit) on EAN-13 barcodes that begin with “978”. The following settings can be programmed:

Require Add-On Code: All EAN-13 barcodes that begin with “978” must have a 2-digit or 5-digit add-on code. The EAN-13 barcode with the add-on code is then transmitted. If the required add-on code is not found, the EAN-13 barcode is discarded.

Do Not Require Add-On Code: If you have selected **Require Add-On Code**, and you want to disable this feature, scan **Do Not Require Add-On Code**. EAN-13 barcodes are handled, depending on your selection for the “Add-On Code Required” feature.



@E139780

**** Do Not Require Add-On Code**



@E139781

Require Add-On Code



@SETUPE0

**** Exit Setup**



Enter Setup

EAN-13 Beginning with 979 Add-On Code Required

This setting programs the scanner to require an add-on code (2-digit or 5-digit) on EAN-13 barcodes that begin with “979”. The following settings can be programmed:

Require Add-On Code: All EAN-13 barcodes that begin with “979” must have a 2-digit or 5-digit add-on code. The EAN-13 barcode with the add-on code is then transmitted. If the required add-on code is not found, the EAN-13 barcode is discarded.

Do Not Require Add-On Code: If you have selected **Require Add-On Code**, and you want to disable this feature, scan **Do Not Require Add-On Code**. EAN-13 barcodes are handled, depending on your selection for the “Add-On Code Required” feature.



**** Do Not Require Add-On Code**



Require Add-On Code



**** Exit Setup**



@SETUPE1

Enter Setup

UPC-E

Restore Factory Defaults



@UPEDEF

Restore the Factory Defaults of UPC-E

Enable/Disable UPC-E



@UPEENA1

**** Enable UPC-E**



@UPEENA0

Disable UPC-E



If the scanner fails to identify UPC-E barcodes, you may first try this solution by scanning the **Enter Setup** barcode and then **Enable UPC-E** barcode.

UPC-E0



@UPEEN01

****Enable UPC-E0**



@UPEEN00

Disable UPC-E0



@SETUPE0

**** Exit Setup**



@SETUPE1

Enter Setup

UPC-E1



@UPEEN11

Enable UPC-E1



@UPEEN10

**** Disable UPC-E1**

Transmit Check Character

UPC-E is 8 digits in length with the last one as its check character used to verify the integrity of the data.



@UPECHK2

**** Transmit UPC-E Check Character**



@UPECHK1

Do Not Transmit UPC-E Check Character



@SETUPE0

**** Exit Setup**



@SETUPE1

Enter Setup

2-Digit Add-On Code

A UPC-E barcode can be augmented with a two-digit add-on code to form a new one. In the example below, the part surrounded by blue dotted line is a UPC-E barcode while the part circled by red dotted line is a two-digit add-on code.



@UPEAD20

** Disable 2-Digit Add-On Code



@UPEAD21

Enable 2-Digit Add-On Code



Disable 2-Digit Add-On Code: The scanner decodes UPC-E and ignores the add-on code when presented with a UPC-E plus 2-digit add-on barcode. It can also decode UPC-E barcodes without 2-digit add-on codes.

Enable 2-Digit Add-On Code: The scanner decodes a mix of UPC-E barcodes with and without 2-digit add-on codes.



@SETUPE0

** Exit Setup



Enter Setup

5-Digit Add-On Code

A UPC-E barcode can be augmented with a five-digit add-on code to form a new one. In the example below, the part surrounded by blue dotted line is a UPC-E barcode while the part circled by red dotted line is a five-digit add-on code.



**** Disable 5-Digit Add-On Code**



Enable 5-Digit Add-On Code



Disable 5-Digit Add-On Code: The scanner decodes UPC-E and ignores the add-on code when presented with a UPC-E plus 5-digit add-on barcode. It can also decode UPC-E barcodes without 5-digit add-on codes.

Enable 5-Digit Add-On Code: The scanner decodes a mix of UPC-E barcodes with and without 5-digit add-on codes.



**** Exit Setup**



@SETUPE1

Enter Setup

Transmit Preamble Character

Preamble characters (Country Code and System Character) can be transmitted as part of a UPC-E barcode. Select one of the following options for transmitting UPC-E preamble to the host device: transmit system character only, transmit system character and country code ("0" for USA), or transmit no preamble.



@UPEPRE1

**** System Character**



@UPEPRE0

No Preamble



@UPEPRE2

System Character & Country Code

Convert UPC-E to UPC-A

Convert UPC-E to UPC-A: Convert UPC-E (zero suppressed) decoded data to UPC-A format before transmission. After conversion, the data follows UPC-A format and is affected by UPC-A programming selections (e.g., Preamble, Check Character).

Do Not Convert UPC-E to UPC-A: UPC-E decoded data is transmitted as UPC-E data, without conversion.



@UPEEXP0

**** Do Not Convert UPC-E to UPC-A**



@UPEEXP1

Convert UPC-E to UPC-A



@SETUPE0

**** Exit Setup**



@SETUPE1

Enter Setup

UPC-A

Restore Factory Defaults



@UPADEF

Restore the Factory Defaults of UPC-A

Enable/Disable UPC-A



@UPAENA1

**** Enable UPC-A**



@UPAENA0

Disable UPC-A



If the scanner fails to identify UPC-A barcodes, you may first try this solution by scanning the **Enter Setup** barcode and then **Enable UPC-A** barcode.

Transmit Check Character

UPC-A is 13 digits in length with the last one as its check character used to verify the integrity of the data.



@UPACHK2

**** Transmit UPC-A Check Character**



@UPACHK1

Do Not Transmit UPC-A Check Character



@SETUPE0

**** Exit Setup**



@SETUPE1

Enter Setup

2-Digit Add-On Code

A UPC-A barcode can be augmented with a two-digit add-on code to form a new one. In the example below, the part surrounded by blue dotted line is a UPC-A barcode while the part circled by red dotted line is a two-digit add-on code.



@UPAAD20

** Disable 2-Digit Add-On Code



@UPAAD21

Enable 2-Digit Add-On Code



Disable 2-Digit Add-On Code: The scanner decodes UPC-A and ignores the add-on code when presented with a UPC-A plus 2-digit add-on barcode. It can also decode UPC-A barcodes without 2-digit add-on codes.

Enable 2-Digit Add-On Code: The scanner decodes a mix of UPC-A barcodes with and without 2-digit add-on codes.



@SETUPE0

** Exit Setup



Enter Setup

5-Digit Add-On Code

A UPC-A barcode can be augmented with a five-digit add-on code to form a new one. In the example below, the part surrounded by blue dotted line is a UPC-A barcode while the part circled by red dotted line is a five-digit add-on code.



**** Disable 5-Digit Add-On Code**



Enable 5-Digit Add-On Code



Disable 5-Digit Add-On Code: The scanner decodes UPC-A and ignores the add-on code when presented with a UPC-A plus 5-digit add-on barcode. It can also decode UPC-A barcodes without 5-digit add-on codes.

Enable 5-Digit Add-On Code: The scanner decodes a mix of UPC-A barcodes with and without 5-digit add-on codes.



**** Exit Setup**



@SETUPE1

Enter Setup

Transmit Preamble Character

Preamble characters (Country Code and System Character) can be transmitted as part of a UPC-A barcode. Select one of the following options for transmitting UPC-A preamble to the host device: transmit system character only, transmit system character and country code ("0" for USA), or transmit no preamble.



@UPAPRE0

**** No Preamble**



@UPAPRE1

System Character



@UPAPRE2

System Character & Country Code



@SETUPE0

**** Exit Setup**



Enter Setup

Coupon

UPC-A/EAN-13 with Extended Coupon Code

The following three types of coupon code + extended coupon code are supported:

- ◇ UPC-A (starting with “5”) + GS1-128
- ◇ UPC-A (starting with “5”) + GS1 Databar
- ◇ EAN-13 (starting with “99”) + GS1-128

Use the appropriate barcode below to enable or disable UPC-A/EAN-13 with Extended Coupon Code. When left on the default setting (**Off**), the scanner treats Coupon Codes and Extended Coupon Codes as single bar codes.

If you scan the **Allow Concatenation** code, when the scanner sees the coupon code and the extended coupon code in a single scan, it transmits both as separate symbologies. Otherwise, it transmits the first coupon code it reads.

If you scan the **Require Concatenation** code, the scanner must see and read the coupon code and extended coupon code in a single read to transmit the data. No data is output unless both codes are read.



**** Off**



Allow Concatenation



Require Concatenation



When using the UPC-A Coupon feature, please ensure that **System Character** or **System Character & Country Code** is selected for the “Transmit UPC-A Preamble Character” feature.



**** Exit Setup**



@SETUPE1

Enter Setup

Coupon GS1 Databar Output

If you scan coupons that have both UPC and GS1 Databar codes, you may wish to scan and output only the data from the GS1 Databar code. Scan the **GS1 Output On** barcode below to scan and output only the GS1 Databar code data.

When **GS1 Output Off** is selected, coupons that have both UPC and GS1 Databar codes are transmitted depending on your selection for the “UPC-A/EAN-13 with Extended Coupon Code” feature.



@CPNGS10

**** GS1 Output Off**



@CPNGS11

GS1 Output On



When using the UPC-A Coupon feature, please ensure that **System Character** or **System Character & Country Code** is selected for the “Transmit UPC-A Preamble Character” feature.



@SETUPE0

**** Exit Setup**



@SETUPE1

Enter Setup

Interleaved 2 of 5

Restore Factory Defaults



@I25DEF

Restore the Factory Defaults of Interleaved 2 of 5

Enable/Disable Interleaved 2 of 5



@I25ENA1

Enable Interleaved 2 of 5



@I25ENA0

**** Disable Interleaved 2 of 5**



If the scanner fails to identify Interleaved 2 of 5 barcodes, you may first try this solution by scanning the **Enter Setup** barcode and then **Enable Interleaved 2 of 5** barcode.



@SETUPE0

**** Exit Setup**



@SETUPE1

Enter Setup

Set Length Range for Interleaved 2 of 5

The scanner can be configured to only decode Interleaved 2 of 5 barcodes with lengths that fall between (inclusive) the minimum and maximum lengths. To accomplish it, you need to set the minimum and maximum lengths.



@I25MIN

Set the Minimum Length (Default: 6)



@I25MAX

Set the Maximum Length (Default: 80)



If minimum length is set to be greater than maximum length, the scanner only decodes Interleaved 2 of 5 barcodes with either the minimum or maximum length. If minimum length is same as maximum length, only Interleaved 2 of 5 barcodes with that length are to be decoded.

Set the scanner to decode Interleaved 2 of 5 barcodes containing between 8 and 12 characters:

E
sample

1. Scan the **Enter Setup** barcode.
2. Scan the **Set the Minimum Length** barcode.
3. Scan the numeric barcode “8” from the “Digit Barcodes” section in Appendix.
4. Scan the **Save** barcode from the “Save/Cancel Barcodes” section in Appendix.
5. Scan the **Set the Maximum Length** barcode.
6. Scan the numeric barcodes “1” and “2” from the “Digit Barcodes” section in Appendix.
7. Scan the **Save** barcode from the “Save/Cancel Barcodes” section in Appendix.
8. Scan the **Exit Setup** barcode.



@SETUPE0

**** Exit Setup**



@SETUPE1

Enter Setup

Check Character Verification

A check character is optional for Interleaved 2 of 5 and can be added as the last character. It is a calculated value used to verify the integrity of the data.

- ◇ **Disable:** The scanner transmits Interleaved 2 of 5 barcodes as is.
- ◇ **Do Not Transmit Check Character After Verification:** The scanner checks the integrity of all Interleaved 2 of 5 barcodes to verify that the data complies with the check character algorithm. Barcodes passing the check will be transmitted except the last digit, whereas those failing it will not be transmitted.
- ◇ **Transmit Check Character After Verification:** The scanner checks the integrity of all Interleaved 2 of 5 barcodes to verify that the data complies with the check character algorithm. Barcodes passing the check will be transmitted, whereas those failing it will not be transmitted.

Since Interleaved 2 of 5 must always have an even number of digits, a zero may need to be added as the first digit when the check character is added. The check character is automatically generated when making Interleaved 2 of 5 barcodes.



@I25CHK0
** Disable



@I25CHK1

Do Not Transmit Check Character After Verification



@I25CHK2

Transmit Check Character After Verification



If the **Do Not Transmit Check Character After Verification** option is enabled, Interleaved 2 of 5 barcodes with a length that is less than the configured minimum length after having the check character excluded will not be decoded. (For example, when the **Do Not Transmit Check Character After Verification** option is enabled and the minimum length is set to 4, Interleaved 2 of 5 barcodes with a total length of 4 characters including the check character cannot be read.)



@SETUPE0

** Exit Setup



@SETUPE1

Enter Setup

Febraban

Disable/Enable Febraban



@I25FBB0

**** Disable Febraban**



@I25FBB2

Enable Febraban, Expand



@I25FBB1

Enable Febraban, Do Not Expand

Transmit Delay per Character

Transmit Delay per Character applies to both Expanded and Unexpanded Febraban. This feature is available only when USB HID Keyboard is enabled.



@FEBSENO

**** Disable Transmit Delay per Character**



@FEBSEN1

Enable Transmit Delay per Character



@SETUPE0

**** Exit Setup**



@SETUPE1

Enter Setup

You may select an appropriate delay value from the options below as per your actual needs.



@FEBSDT0

0ms



@FEBSDT5

5ms



@FEBSDT10

10ms



@FEBSDT15

15ms



@FEBSDT20

20ms



@FEBSDT25

25ms



@FEBSDT30

30ms



@FEBSDT35

35ms



@SETUPE0

**** Exit Setup**



@SETUPE1

Enter Setup



@FEBSDT40

40ms



@FEBSDT45

45ms



@FEBSDT50

50ms



@FEBSDT55

55ms



@FEBSDT60

60ms



@FEBSDT65

65ms



@FEBSDT70

** 70ms



@FEBSDT75

75ms



@SETUPE0

** Exit Setup



@SETUPE1

Enter Setup

Transmit Delay per 12 Characters

Transmit Delay per 12 Characters applies to Expanded Febraban only. This feature is available only when USB HID Keyboard is enabled.



@FEBMENO

**** Disable Transmit Delay per 12 Characters**



@FEBMEN1

Enable Transmit Delay per 12 Characters

You may select an appropriate delay value from the options below as per your actual needs.



@FEBMDT0

0ms



@FEBMDT1

300ms



@FEBMDT2

400ms



@SETUPE0

**** Exit Setup**



@SETUPE1

Enter Setup



@FEBMDT4

600ms



@FEBMDT6

800ms



@FEBMDT3

**** 500ms**



@FEBMDT5

700ms



@FEBMDT7

900ms



@SETUPE0

**** Exit Setup**



Enter Setup

ITF-14

ITF-14 is a special kind of Interleaved 2 of 5 with a length of 14 characters and the last character as the check character.

ITF-14 priority principle: For the Interleaved 2 of 5 barcodes with a length of 14 characters and the last character as the check character, the ITF-14 configurations shall take precedence over the Interleaved 2 of 5 settings.

Restore Factory Defaults



Restore the Factory Defaults of ITF-14

Enable/Disable ITF-14



**** Disable ITF-14**



Enable ITF-14 But Do Not Transmit Check Character



Enable ITF-14 and Transmit Check Character



An example of the ITF-14 priority principle: when ITF-14 is enabled and Interleaved 2 of 5 is disabled, the scanner only decodes Interleaved 2 of 5 barcodes with a length of 14 characters and the last character as the check character.



**** Exit Setup**



@SETUPE1

Enter Setup

ITF-6

ITF-6 is a special kind of Interleaved 2 of 5 with a length of 6 characters and the last character as the check character.

ITF-6 priority principle: For the Interleaved 2 of 5 barcodes with a length of 6 characters and the last character as the check character, the ITF-6 configurations shall take precedence over the Interleaved 2 of 5 settings.

Restore Factory Defaults



@IT6DEF

Restore the Factory Defaults of ITF-6

Enable/Disable ITF-6



@IT6ENA0

** Disable ITF-6



@IT6ENA1

Enable ITF-6 But Do Not Transmit Check Character



@IT6ENA2

Enable ITF-6 and Transmit Check Character



An example of the ITF-6 priority principle: when ITF-6 is enabled and Interleaved 2 of 5 is disabled, the scanner only decodes Interleaved 2 of 5 barcodes with a length of 6 characters and the last character as the check character.



@SETUPE0

** Exit Setup



@SETUPE1

Enter Setup

Matrix 2 of 5

Restore Factory Defaults



@M25DEF

Restore the Factory Defaults of Matrix 2 of 5

Enable/Disable Matrix 2 of 5



@M25ENA1

Enable Matrix 2 of 5



@M25ENA0

**** Disable Matrix 2 of 5**



If the scanner fails to identify Matrix 2 of 5 barcodes, you may first try this solution by scanning the **Enter Setup** barcode and then **Enable Matrix 2 of 5** barcode.



@SETUPE0

**** Exit Setup**



@SETUPE1

Enter Setup

Set Length Range for Matrix 2 of 5

The scanner can be configured to only decode Matrix 2 of 5 barcodes with lengths that fall between (inclusive) the minimum and maximum lengths. To accomplish it, you need to set the minimum and maximum lengths.



@M25MIN

Set the Minimum Length (Default: 4)



@M25MAX

Set the Maximum Length (Default: 80)



If minimum length is set to be greater than maximum length, the scanner only decodes Matrix 2 of 5 barcodes with either the minimum or maximum length. If minimum length is same as maximum length, only Matrix 2 of 5 barcodes with that length are to be decoded.

E *example*

Set the scanner to decode Matrix 2 of 5 barcodes containing between 8 and 12 characters:

1. Scan the **Enter Setup** barcode.
2. Scan the **Set the Minimum Length** barcode.
3. Scan the numeric barcode “8” from the “Digit Barcodes” section in Appendix.
4. Scan the **Save** barcode from the “Save/Cancel Barcodes” section in Appendix.
5. Scan the **Set the Maximum Length** barcode.
6. Scan the numeric barcodes “1” and “2” from the “Digit Barcodes” section in Appendix.
7. Scan the **Save** barcode from the “Save/Cancel Barcodes” section in Appendix.
8. Scan the **Exit Setup** barcode.



@SETUPE0

**** Exit Setup**



Enter Setup

Check Character Verification

A check character is optional for Matrix 2 of 5 and can be added as the last character. It is a calculated value used to verify the integrity of the data.

- ◇ **Disable:** The scanner transmits Matrix 2 of 5 barcodes as is.
- ◇ **Do Not Transmit Check Character After Verification:** The scanner checks the integrity of all Matrix 2 of 5 barcodes to verify that the data complies with the check character algorithm. Barcodes passing the check will be transmitted except the last digit, whereas those failing it will not be transmitted.
- ◇ **Transmit Check Character After Verification:** The scanner checks the integrity of all Matrix 2 of 5 barcodes to verify that the data complies with the check character algorithm. Barcodes passing the check will be transmitted, whereas those failing it will not be transmitted.

Since Matrix 2 of 5 must always have an even number of digits, a zero may need to be added as the first digit when the check character is added. The check character is automatically generated when making Matrix 2 of 5 barcodes.



@M25CHK0
**** Disable**



Do Not Transmit Check Character After Verification



Transmit Check Character After Verification



If the **Do Not Transmit Check Character After Verification** option is enabled, Matrix 2 of 5 barcodes with a length that is less than the configured minimum length after having the check character excluded will not be decoded. (For example, when the **Do Not Transmit Check Character After Verification** option is enabled and the minimum length is set to 4, Matrix 2 of 5 barcodes with a total length of 4 characters including the check character cannot be read.)



**** Exit Setup**



@SETUPE1

Enter Setup

Code 39

Restore Factory Defaults



@C39DEF

Restore the Factory Defaults of Code 39

Enable/Disable Code 39



@C39ENA1

**** Enable Code 39**



@C39ENA0

Disable Code 39



If the scanner fails to identify Code 39 barcodes, you may first try this solution by scanning the **Enter Setup** barcode and then **Enable Code 39** barcode.



@SETUPE0

**** Exit Setup**



@SETUPE1
Enter Setup

Set Length Range for Code 39

The scanner can be configured to only decode Code 39 barcodes with lengths that fall between (inclusive) the minimum and maximum lengths. To accomplish it, you need to set the minimum and maximum lengths.



@C39MIN
Set the Minimum Length (Default: 1)



@C39MAX
Set the Maximum Length (Default: 48)



If minimum length is set to be greater than maximum length, the scanner only decodes Code 39 barcodes with either the minimum or maximum length. If minimum length is same as maximum length, only Code 39 barcodes with that length are to be decoded.



Set the scanner to decode Code 39 barcodes containing between 8 and 12 characters:

1. Scan the **Enter Setup** barcode.
2. Scan the **Set the Minimum Length** barcode.
3. Scan the numeric barcode “8” from the “Digit Barcodes” section in Appendix.
4. Scan the **Save** barcode from the “Save/Cancel Barcodes” section in Appendix.
5. Scan the **Set the Maximum Length** barcode.
6. Scan the numeric barcodes “1” and “2” from the “Digit Barcodes” section in Appendix.
7. Scan the **Save** barcode from the “Save/Cancel Barcodes” section in Appendix.
8. Scan the **Exit Setup** barcode.



@SETUPE0
**** Exit Setup**



@SETUPE1

Enter Setup

Check Character Verification

A check character is optional for Code 39 and can be added as the last character. It is a calculated value used to verify the integrity of the data.

- ◇ **Disable:** The scanner transmits Code 39 barcodes as is.
- ◇ **Do Not Transmit Check Character After Verification:** The scanner checks the integrity of all Code 39 barcodes to verify that the data complies with the check character algorithm. Barcodes passing the check will be transmitted except the last digit, whereas those failing it will not be transmitted.
- ◇ **Transmit Check Character After Verification:** The scanner checks the integrity of all Code 39 barcodes to verify that the data complies with the check character algorithm. Barcodes passing the check will be transmitted, whereas those failing it will not be transmitted.



@C39CHK0

** Disable



@C39CHK1

Do Not Transmit Check Character After Verification



@C39CHK2

Transmit Check Character After Verification



If the **Do Not Transmit Check Character After Verification** option is enabled, Code 39 barcodes with a length that is less than the configured minimum length after having the check character excluded will not be decoded. (For example, when the **Do Not Transmit Check Character After Verification** option is enabled and the minimum length is set to 4, Code 39 barcodes with a total length of 4 characters including the check character cannot be read.)



@SETUPE0

** Exit Setup



@SETUPE1

Enter Setup

Transmit Start/Stop Character

Code 39 uses an asterisk (*) for both the start and the stop characters. You can choose whether or not to transmit the start/stop characters by scanning the appropriate barcode below.



@C39TSC0

**** Do Not Transmit Start/Stop Character**



@C39TSC1

Transmit Start/Stop Character

Enable/Disable Code 39 Full ASCII

The scanner can be configured to identify all ASCII characters by scanning the appropriate barcode below.



@C39ASC0

**** Disable Code 39 Full ASCII**



@C39ASC1

Enable Code 39 Full ASCII



@SETUPE0

**** Exit Setup**



@SETUPE1

Enter Setup

Enable/Disable Code 32 (Italian Pharma Code)

Code 32 is a variant of Code 39 used by the Italian pharmaceutical industry. Scan the appropriate bar code below to enable or disable Code 32. Code 39 must be enabled and Code 39 check character verification must be disabled for this parameter to function.



@C39E320

**** Disable Code 32**



@C39E321

Enable Code 32

Code 32 Prefix

Scan the appropriate barcode below to enable or disable adding the prefix character "A" to all Code 32 barcodes. Code 32 must be enabled for this parameter to function.



@C39S320

**** Disable Code 32 Prefix**



@C39S321

Enable Code 32 Prefix



@SETUPE0

**** Exit Setup**



@SETUPE1

Enter Setup

Transmit Code 32 Start/Stop Character

Code 32 must be enabled for this parameter to function.



@C39T320

**** Do Not Transmit Code 32 Start/Stop Character**



@C39T321

Transmit Code 32 Start/Stop Character

Transmit Code 32 Check Character

Code 32 must be enabled for this parameter to function.



@C39C320

**** Do Not Transmit Code 32 Check Character**



@C39C321

Transmit Code 32 Check Character



@SETUPE0

**** Exit Setup**



@SETUPE1

Enter Setup

Codabar

Restore Factory Defaults



@CBADEF

Restore the Factory Defaults of Codabar

Enable/Disable Codabar



@CBAENA1

Enable Codabar



@CBAENA0

**** Disable Codabar**



If the scanner fails to identify Codabar barcodes, you may first try this solution by scanning the **Enter Setup** barcode and then **Enable Codabar** barcode.



@SETUPE0

**** Exit Setup**



@SETUPE1

Enter Setup

Set Length Range for Codabar

The scanner can be configured to only decode Codabar barcodes with lengths that fall between (inclusive) the minimum and maximum lengths. To accomplish it, you need to set the minimum and maximum lengths.



@CBAMIN

Set the Minimum Length (Default: 2)



@CBAMAX

Set the Maximum Length (Default: 60)



If minimum length is set to be greater than maximum length, the scanner only decodes Codabar barcodes with either the minimum or maximum length. If minimum length is same as maximum length, only Codabar barcodes with that length are to be decoded.

E
sample

Set the scanner to decode Codabar barcodes containing between 8 and 12 characters:

1. Scan the **Enter Setup** barcode.
2. Scan the **Set the Minimum Length** barcode.
3. Scan the numeric barcode “8” from the “Digit Barcodes” section in Appendix.
4. Scan the **Save** barcode from the “Save/Cancel Barcodes” section in Appendix.
5. Scan the **Set the Maximum Length** barcode.
6. Scan the numeric barcodes “1” and “2” from the “Digit Barcodes” section in Appendix.
7. Scan the **Save** barcode from the “Save/Cancel Barcodes” section in Appendix.
8. Scan the **Exit Setup** barcode.



@SETUPE0

**** Exit Setup**



@SETUPE1

Enter Setup

Check Character Verification

A check character is optional for Codabar and can be added as the last character. It is a calculated value used to verify the integrity of the data.

- ◇ **Disable:** The scanner transmits Codabar barcodes as is.
- ◇ **Do Not Transmit Check Character After Verification:** The scanner checks the integrity of all Codabar barcodes to verify that the data complies with the check character algorithm. Barcodes passing the check will be transmitted except the last digit, whereas those failing it will not be transmitted.
- ◇ **Transmit Check Character After Verification:** The scanner checks the integrity of all Codabar barcodes to verify that the data complies with the check character algorithm. Barcodes passing the check will be transmitted, whereas those failing it will not be transmitted.



@CBACHK0

** Disable



@CBACHK1

Do Not Transmit Check Character After Verification



@CBACHK2

Transmit Check Character After Verification



If the **Do Not Transmit Check Character After Verification** option is enabled, Codabar barcodes with a length that is less than the configured minimum length after having the check character excluded will not be decoded. (For example, when the **Do Not Transmit Check Character After Verification** option is enabled and the minimum length is set to 4, Codabar barcodes with a total length of 4 characters including the check character cannot be read.)



@SETUPE0

** Exit Setup



@SETUPE1

Enter Setup

Start/Stop Character

You can set the start/stop characters and choose whether or not to transmit the start/stop characters by scanning the appropriate barcode below.



@CBATSC0

**** Do Not Transmit Start/Stop Character**



@CBATSC1

Transmit Start/Stop Character



@CBASCF0

**** ABCD/ABCD as the Start/Stop Character**



@CBASCF1

ABCD/TN*E as the Start/Stop Character



@CBASCF2

abcd/abcd as the Start/Stop Character



@CBASCF3

abcd/tn*e as the Start/Stop Character



@SETUPE0

**** Exit Setup**



@SETUPE1

Enter Setup

Code 93

Restore Factory Defaults



@C93DEF

Restore the Factory Defaults of Code 93

Enable/Disable Code 93



@C93ENA1

Enable Code 93



@C93ENA0

**** Disable Code 93**



If the scanner fails to identify Code 93 barcodes, you may first try this solution by scanning the **Enter Setup** barcode and then **Enable Code 93** barcode.



@SETUPE0

**** Exit Setup**



@SETUPE1

Enter Setup

Set Length Range for Code 93

The scanner can be configured to only decode Code 93 barcodes with lengths that fall between (inclusive) the minimum and maximum lengths. To accomplish it, you need to set the minimum and maximum lengths.



@C93MIN

Set the Minimum Length (Default: 1)



@C93MAX

Set the Maximum Length (Default: 48)



If minimum length is set to be greater than maximum length, the scanner only decodes Code 93 barcodes with either the minimum or maximum length. If minimum length is same as maximum length, only Code 93 barcodes with that length are to be decoded.



Set the scanner to decode Code 93 barcodes containing between 8 and 12 characters:

1. Scan the **Enter Setup** barcode.
2. Scan the **Set the Minimum Length** barcode.
3. Scan the numeric barcode “8” from the “Digit Barcodes” section in Appendix.
4. Scan the **Save** barcode from the “Save/Cancel Barcodes” section in Appendix.
5. Scan the **Set the Maximum Length** barcode.
6. Scan the numeric barcodes “1” and “2” from the “Digit Barcodes” section in Appendix.
7. Scan the **Save** barcode from the “Save/Cancel Barcodes” section in Appendix.
8. Scan the **Exit Setup** barcode.



@SETUPE0

**** Exit Setup**



@SETUPE1

Enter Setup

Check Character Verification

Check characters are optional for Code 93 and can be added as the last two characters, which are calculated values used to verify the integrity of the data.

- ❖ **Disable:** The scanner transmits Code 93 barcodes as is.
- ❖ **Do Not Transmit Check Character After Verification:** The scanner checks the integrity of all Code 93 barcodes to verify that the data complies with the check character algorithm. Barcodes passing the checks will be transmitted except the last two digits, whereas those failing them will not be transmitted.
- ❖ **Transmit Check Character After Verification:** The scanner checks the integrity of all Code 93 barcodes to verify that the data complies with the check character algorithm. Barcodes passing the checks will be transmitted, whereas those failing them will not be transmitted.



@C93CHK0

Disable



@C93CHK1

**** Do Not Transmit Check Character After Verification**



@C93CHK2

Transmit Check Character After Verification



If the **Do Not Transmit Check Character After Verification** option is enabled, Code 93 barcodes with a length that is less than the configured minimum length after having the two check characters excluded will not be decoded. (For example, when the **Do Not Transmit Check Character After Verification** option is enabled and the minimum length is set to 4, Code 93 barcodes with a total length of 4 characters including the two check characters cannot be read.)



@SETUPE0

**** Exit Setup**



@SETUPE1

Enter Setup

China Post 25

Restore Factory Defaults



@CHPDEF

Restore the Factory Defaults of China Post 25

Enable/Disable China Post 25



@CHPENA1

Enable China Post 25



@CHPENA0

**** Disable China Post 25**



If the scanner fails to identify China Post 25 barcodes, you may first try this solution by scanning the **Enter Setup** barcode and then **Enable China Post 25** barcode.



@SETUPE0

**** Exit Setup**



@SETUPE1

Enter Setup

Set Length Range for China Post 25

The scanner can be configured to only decode China Post 25 barcodes with lengths that fall between (inclusive) the minimum and maximum lengths. To accomplish it, you need to set the minimum and maximum lengths.



@CHPMIN

Set the Minimum Length (Default: 1)



@CHPMAX

Set the Maximum Length (Default: 48)



If minimum length is set to be greater than maximum length, the scanner only decodes China Post 25 barcodes with either the minimum or maximum length. If minimum length is same as maximum length, only China Post 25 barcodes with that length are to be decoded.

Set the scanner to decode China Post 25 barcodes containing between 8 and 12 characters:

E
sample

1. Scan the **Enter Setup** barcode.
2. Scan the **Set the Minimum Length** barcode.
3. Scan the numeric barcode “8” from the “Digit Barcodes” section in Appendix.
4. Scan the **Save** barcode from the “Save/Cancel Barcodes” section in Appendix.
5. Scan the **Set the Maximum Length** barcode.
6. Scan the numeric barcodes “1” and “2” from the “Digit Barcodes” section in Appendix.
7. Scan the **Save** barcode from the “Save/Cancel Barcodes” section in Appendix.
8. Scan the **Exit Setup** barcode.



@SETUPE0

**** Exit Setup**



Enter Setup

Check Character Verification

A check character is optional for China Post 25 and can be added as the last character. It is a calculated value used to verify the integrity of the data.

- ◇ **Disable:** The scanner transmits China Post 25 barcodes as is.
- ◇ **Do Not Transmit Check Character After Verification:** The scanner checks the integrity of all China Post 25 barcodes to verify that the data complies with the check character algorithm. Barcodes passing the check will be transmitted except the last digit, whereas those failing it will not be transmitted.
- ◇ **Transmit Check Character After Verification:** The scanner checks the integrity of all China Post 25 barcodes to verify that the data complies with the check character algorithm. Barcodes passing the check will be transmitted, whereas those failing it will not be transmitted.



@CHPCHK0
**** Disable**

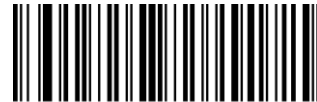

Do Not Transmit Check Character After Verification



Transmit Check Character After Verification



If the **Do Not Transmit Check Character After Verification** option is enabled, China Post 25 barcodes with a length that is less than the configured minimum length after having the check character excluded will not be decoded. (For example, when the **Do Not Transmit Check Character After Verification** option is enabled and the minimum length is set to 4, China Post 25 barcodes with a total length of 4 characters including the check character cannot be read.)



**** Exit Setup**



@SETUPE1

Enter Setup

GS1-128 (UCC/EAN-128)

Restore Factory Defaults



@GS1DEF

Restore the Factory Defaults of GS1-128

Enable/Disable GS1-128



@GS1ENA1

**** Enable GS1-128**



@GS1ENA0

Disable GS1-128



If the scanner fails to identify GS1-128 barcodes, you may first try this solution by scanning the **EnterSetup** barcode and then **Enable GS1-128** barcode.



@SETUPE0

**** Exit Setup**



@SETUPE1

Enter Setup

Set Length Range for GS1-128

The scanner can be configured to only decode GS1-128 barcodes with lengths that fall between (inclusive) the minimum and maximum lengths. To accomplish it, you need to set the minimum and maximum lengths.



@GS1MIN

Set the Minimum Length (Default: 1)



@GS1MAX

Set the Maximum Length (Default: 48)



If minimum length is set to be greater than maximum length, the scanner only decodes GS1-128 barcodes with either the minimum or maximum length. If minimum length is same as maximum length, only GS1-128 barcodes with that length are to be decoded.

Set the scanner to decode GS1-128 barcodes containing between 8 and 12 characters:

E
sample

1. Scan the **Enter Setup** barcode.
2. Scan the **Set the Minimum Length** barcode.
3. Scan the numeric barcode “8” from the “Digit Barcodes” section in Appendix.
4. Scan the **Save** barcode from the “Save/Cancel Barcodes” section in Appendix.
5. Scan the **Set the Maximum Length** barcode.
6. Scan the numeric barcodes “1” and “2” from the “Digit Barcodes” section in Appendix.
7. Scan the **Save** barcode from the “Save/Cancel Barcodes” section in Appendix.
8. Scan the **Exit Setup** barcode.



@SETUPE0

**** Exit Setup**



@SETUPE1

Enter Setup

GS1 Databar (RSS)

Restore Factory Defaults



@RSSDEF

Restore the Factory Defaults of GS1 Databar

Enable/Disable GS1 Databar



@RSSENA1

Enable GS1 Databar



@RSSENA0

**** Disable GS1 Databar**



If the scanner fails to identify GS1 Databar barcodes, you may first try this solution by scanning the **Enter Setup** barcode and then **Enable GS1 Databar** barcode.

Transmit Application Identifier "01"



@RSSTA1

Transmit Application Identifier "01"



@RSSTA0

**** Do Not Transmit Application Identifier "01"**



@SETUPE0

**** Exit Setup**



@SETUPE1

Enter Setup

GS1 Composite (EAN·UCC Composite)

Restore Factory Defaults



@CPTDEF

Restore the Factory Defaults of GS1 Composite

Enable/Disable GS1 Composite



@CPTENA1

Enable GS1 Composite



@CPTENA0

**** Disable GS1 Composite**



If the scanner fails to identify GS1 Composite barcodes, you may first try this solution by scanning the **Enter Setup** barcode and then **Enable GS1 Composite** barcode.

Enable/Disable UPC/EAN Composite

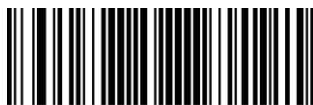

@CPTUPC1

Enable UPC/EAN Composite



@CPTUPC0

**** Disable UPC/EAN Composite**



@SETUPE0

**** Exit Setup**



@SETUPE1

Enter Setup

Code 11

Restore Factory Defaults



@C11DEF

Restore the Factory Defaults of Code 11

Enable/Disable Code 11



@C11ENA1

Enable Code 11



@C11ENA0

**** Disable Code 11**



If the scanner fails to identify Code 11 barcodes, you may first try this solution by scanning the **Enter Setup** barcode and then **Enable Code 11** barcode.



@SETUPE0

**** Exit Setup**



@SETUPE1

Enter Setup

Set Length Range for Code 11

The scanner can be configured to only decode Code 11 barcodes with lengths that fall between (inclusive) the minimum and maximum lengths. To accomplish it, you need to set the minimum and maximum lengths.



@C11MIN

Set the Minimum Length (Default: 4)



@C11MAX

Set the Maximum Length (Default: 48)



If minimum length is set to be greater than maximum length, the scanner only decodes Code 11 barcodes with either the minimum or maximum length. If minimum length is same as maximum length, only Code 11 barcodes with that length are to be decoded.



Set the scanner to decode Code 11 barcodes containing between 8 and 12 characters:

1. Scan the **Enter Setup** barcode.
2. Scan the **Set the Minimum Length** barcode.
3. Scan the numeric barcode “8” from the “Digit Barcodes” section in Appendix.
4. Scan the **Save** barcode from the “Save/Cancel Barcodes” section in Appendix.
5. Scan the **Set the Maximum Length** barcode.
6. Scan the numeric barcodes “1” and “2” from the “Digit Barcodes” section in Appendix.
7. Scan the **Save** barcode from the “Save/Cancel Barcodes” section in Appendix.
8. Scan the **Exit Setup** barcode.



@SETUPE0

**** Exit Setup**



@SETUPE1

Enter Setup

Check Character Verification

Check characters are optional for Code 11 and can be added as the last one or two characters, which are calculated values used to verify the integrity of the data.

If the **Disable** option is enabled, the scanner transmits Code 11 barcodes as is.



@C11CHK0

Disable



@C11CHK1

** One Check Character, MOD11



@C11CHK2

Two Check Characters, MOD11/MOD11



@C11CHK3

Two Check Characters, MOD11/MOD9



@C11CHK4

One Check Character, MOD11 (Len<=10)

Two Check Characters, MOD11/MOD11(Len>10)



@C11CHK5

One Check Character, MOD11 (Len<=10)

Two Check Characters, MOD11/MOD9 (Len>10)



@SETUPE0

** Exit Setup



@SETUPE1

Enter Setup

Transmit Check Character



@C11TCK0

Do Not Transmit Code 11 Check Character



@C11TCK1

** Transmit Code 11 Check Character



If you select a check character algorithm and the **Do Not Transmit Check Character** option, Code 11 barcodes with a length that is less than the configured minimum length after having the check character(s) excluded will not be decoded. (For example, when the **One Check Character, MOD11** and **Do Not Transmit Check Character** options are enabled and the minimum length is set to 4, Code 11 barcodes with a total length of 4 characters including the check character cannot be read.)



@SETUPE0

** Exit Setup



@SETUPE1

Enter Setup

ISBN

Restore Factory Defaults



@ISBDEF

Restore the Factory Defaults of ISBN

Enable/Disable ISBN



@ISBENA1

Enable ISBN



@ISBENA0

**** Disable ISBN**



If the scanner fails to identify ISBN barcodes, you may first try this solution by scanning the **Enter Setup** barcode and then **Enable ISBN** barcode.



@SETUPE0

**** Exit Setup**



@SETUPE1

Enter Setup

Set ISBN Format



@ISBT101

**** ISBN-10**



@ISBT100

ISBN-13



@SETUPE0

**** Exit Setup**



@SETUPE1

Enter Setup

ISSN

Restore Factory Defaults



@ISSDEF

Restore the Factory Defaults of ISSN

Enable/Disable ISSN



@ISSENA1

Enable ISSN



@ISSENA0

**** Disable ISSN**



If the scanner fails to identify ISSN barcodes, you may first try this solution by scanning the **Enter Setup** barcode and then **Enable ISSN** barcode.



@SETUPE0

**** Exit Setup**



@SETUPE1

Enter Setup

Industrial 25

Restore Factory Defaults



@L25DEF

Restore the Factory Defaults of Industrial 25

Enable/Disable Industrial 25



@L25ENA1

Enable Industrial 25



@L25ENA0

**** Disable Industrial 25**



If the scanner fails to identify Industrial 25 barcodes, you may first try this solution by scanning the **Enter Setup** barcode and then **Enable Industrial 25** barcode.



@SETUPE0

**** Exit Setup**



@SETUPE1

Enter Setup

Set Length Range for Industrial 25

The scanner can be configured to only decode Industrial 25 barcodes with lengths that fall between (inclusive) the minimum and maximum lengths. To accomplish it, you need to set the minimum and maximum lengths.



@L25MIN

Set the Minimum Length (Default: 6)



@L25MAX

Set the Maximum Length (Default: 48)



If minimum length is set to be greater than maximum length, the scanner only decodes Industrial 25 barcodes with either the minimum or maximum length. If minimum length is same as maximum length, only Industrial 25 barcodes with that length are to be decoded.

E
sample

Set the scanner to decode Industrial 25 barcodes containing between 8 and 12 characters:

1. Scan the **Enter Setup** barcode.
2. Scan the **Set the Minimum Length** barcode.
3. Scan the numeric barcode “8” from the “Digit Barcodes” section in Appendix.
4. Scan the **Save** barcode from the “Save/Cancel Barcodes” section in Appendix.
5. Scan the **Set the Maximum Length** barcode.
6. Scan the numeric barcodes “1” and “2” from the “Digit Barcodes” section in Appendix.
7. Scan the **Save** barcode from the “Save/Cancel Barcodes” section in Appendix.
8. Scan the **Exit Setup** barcode.



@SETUPE0

**** Exit Setup**



@SETUPE1

Enter Setup

Check Character Verification

A check character is optional for Industrial 25 and can be added as the last character. It is a calculated value used to verify the integrity of the data.

- ◇ **Disable:** The scanner transmits Industrial 25 barcodes as is.
- ◇ **Do Not Transmit Check Character After Verification:** The scanner checks the integrity of all Industrial 25 barcodes to verify that the data complies with the check character algorithm. Barcodes passing the check will be transmitted except the last digit, whereas those failing it will not be transmitted.
- ◇ **Transmit Check Character After Verification:** The scanner checks the integrity of all Industrial 25 barcodes to verify that the data complies with the check character algorithm. Barcodes passing the check will be transmitted, whereas those failing it will not be transmitted.



@L25CHK0

** Disable



@L25CHK1

Do Not Transmit Check Character After Verification



@L25CHK2

Transmit Check Character After Verification



If the **Do Not Transmit Check Character After Verification** option is enabled, Industrial 25 barcodes with a length that is less than the configured minimum length after having the check character excluded will not be decoded. (For example, when the **Do Not Transmit Check Character After Verification** option is enabled and the minimum length is set to 4, Industrial 25 barcodes with a total length of 4 characters including the check character cannot be read.)



@SETUPE0

** Exit Setup



@SETUPE1

Enter Setup

Standard 25

Restore Factory Defaults



@S25DEF

Restore the Factory Defaults of Standard 25

Enable/Disable Standard 25



@S25ENA1

Enable Standard 25



@S25ENA0

**** Disable Standard 25**



If the scanner fails to identify Standard 25 barcodes, you may first try this solution by scanning the **Enter Setup** barcode and then **Enable Standard 25** barcode.



@SETUPE0

**** Exit Setup**



@SETUPE1

Enter Setup

Set Length Range for Standard 25

The scanner can be configured to only decode Standard 25 barcodes with lengths that fall between (inclusive) the minimum and maximum lengths. To accomplish it, you need to set the minimum and maximum lengths.



@S25MIN

Set the Minimum Length (Default: 6)



@S25MAX

Set the Maximum Length (Default: 48)



If minimum length is set to be greater than maximum length, the scanner only decodes Standard 25 barcodes with either the minimum or maximum length. If minimum length is same as maximum length, only Standard 25 barcodes with that length are to be decoded.



Set the scanner to decode Standard 25 barcodes containing between 8 and 12 characters:

1. Scan the **Enter Setup** barcode.
2. Scan the **Set the Minimum Length** barcode.
3. Scan the numeric barcode “8” from the “Digit Barcodes” section in Appendix.
4. Scan the **Save** barcode from the “Save/Cancel Barcodes” section in Appendix.
5. Scan the **Set the Maximum Length** barcode.
6. Scan the numeric barcodes “1” and “2” from the “Digit Barcodes” section in Appendix.
7. Scan the **Save** barcode from the “Save/Cancel Barcodes” section in Appendix.
8. Scan the **Exit Setup** barcode.



@SETUPE0

**** Exit Setup**



Enter Setup

Check Character Verification

A check character is optional for Standard 25 and can be added as the last character. It is a calculated value used to verify the integrity of the data.

- ◇ **Disable:** The scanner transmits Standard 25 barcodes as is.
- ◇ **Do Not Transmit Check Character After Verification:** The scanner checks the integrity of all Standard 25 barcodes to verify that the data complies with the check character algorithm. Barcodes passing the check will be transmitted except the last digit, whereas those failing it will not be transmitted.
- ◇ **Transmit Check Character After Verification:** The scanner checks the integrity of all Standard 25 barcodes to verify that the data complies with the check character algorithm. Barcodes passing the check will be transmitted, whereas those failing it will not be transmitted.



**** Disable**



Do Not Transmit Check Character After Verification



Transmit Check Character After Verification



If the **Do Not Transmit Check Character After Verification** option is enabled, Standard 25 barcodes with a length that is less than the configured minimum length after having the check character excluded will not be decoded. (For example, when the **Do Not Transmit Check Character After Verification** option is enabled and the minimum length is set to 4, Standard 25 barcodes with a total length of 4 characters including the check character cannot be read.)



**** Exit Setup**



@SETUPE1

Enter Setup

Plessey

Restore Factory Defaults



@PLYDEF

Restore the Factory Defaults of Plessey

Enable/Disable Plessey



@PLYENA1

Enable Plessey



@PLYENA0

**** Disable Plessey**



If the scanner fails to identify Plessey barcodes, you may first try this solution by scanning the **Enter Setup** barcode and then **Enable Plessey** barcode.



@SETUPE0

**** Exit Setup**



@SETUPE1

Enter Setup

Set Length Range for Plessey

The scanner can be configured to only decode Plessey barcodes with lengths that fall between (inclusive) the minimum and maximum lengths. To accomplish it, you need to set the minimum and maximum lengths.



@PLYMIN

Set the Minimum Length (Default: 4)



@PLYMAX

Set the Maximum Length (Default: 48)



If minimum length is set to be greater than maximum length, the scanner only decodes Plessey barcodes with either the minimum or maximum length. If minimum length is same as maximum length, only Plessey barcodes with that length are to be decoded.



Set the scanner to decode Plessey barcodes containing between 8 and 12 characters:

1. Scan the **Enter Setup** barcode.
2. Scan the **Set the Minimum Length** barcode.
3. Scan the numeric barcode “8” from the “Digit Barcodes” section in Appendix.
4. Scan the **Save** barcode from the “Save/Cancel Barcodes” section in Appendix.
5. Scan the **Set the Maximum Length** barcode.
6. Scan the numeric barcodes “1” and “2” from the “Digit Barcodes” section in Appendix.
7. Scan the **Save** barcode from the “Save/Cancel Barcodes” section in Appendix.
8. Scan the **Exit Setup** barcode.



@SETUPE0

**** Exit Setup**



@SETUPE1

Enter Setup

Check Character Verification

Check characters are optional for Plessey and can be added as the last two characters, which are calculated values used to verify the integrity of the data.

- ◇ **Disable:** The scanner transmits Plessey barcodes as is.
- ◇ **Do Not Transmit Check Character After Verification:** The scanner checks the integrity of all Plessey barcodes to verify that the data complies with the check character algorithm. Barcodes passing the checks will be transmitted except the last two digits, whereas those failing them will not be transmitted.
- ◇ **Transmit Check Character After Verification:** The scanner checks the integrity of all Plessey barcodes to verify that the data complies with the check character algorithm. Barcodes passing the checks will be transmitted, whereas those failing them will not be transmitted.



@PLYCHK0

** Disable



@PLYCHK1

Do Not Transmit Check Character After Verification



@PLYCHK2

Transmit Check Character After Verification



If the **Do Not Transmit Check Character After Verification** option is enabled, Plessey barcodes with a length that is less than the configured minimum length after having the check characters excluded will not be decoded. (For example, when the **Do Not Transmit Check Character After Verification** option is enabled and the minimum length is set to 4, Plessey barcodes with a total length of 4 characters including the check characters cannot be read.)



@SETUPE0

** Exit Setup



@SETUPE1

Enter Setup

MSI-Plessey

Restore Factory Defaults



@MSIDEF

Restore the Factory Defaults of MSI-Plessey

Enable/Disable MSI-Plessey



@MSIENA1

Enable MSI-Plessey



@MSIENA0

**** Disable MSI-Plessey**



If the scanner fails to identify MSI-Plessey barcodes, you may first try this solution by scanning the **Enter Setup** barcode and then **Enable MSI-Plessey** barcode.



@SETUPE0

**** Exit Setup**



@SETUPE1

Enter Setup

Set Length Range for MSI-Plessey

The scanner can be configured to only decode MSI-Plessey barcodes with lengths that fall between (inclusive) the minimum and maximum lengths. To accomplish it, you need to set the minimum and maximum lengths.



@MSIMIN

Set the Minimum Length (Default: 4)



@MSIMAX

Set the Maximum Length (Default: 48)



If minimum length is set to be greater than maximum length, the scanner only decodes MSI-Plessey barcodes with either the minimum or maximum length. If minimum length is same as maximum length, only MSI-Plessey barcodes with that length are to be decoded.

E
sample

Set the scanner to decode MSI-Plessey barcodes containing between 8 and 12 characters:

1. Scan the **Enter Setup** barcode.
2. Scan the **Set the Minimum Length** barcode.
3. Scan the numeric barcode “8” from the “Digit Barcodes” section in Appendix.
4. Scan the **Save** barcode from the “Save/Cancel Barcodes” section in Appendix.
5. Scan the **Set the Maximum Length** barcode.
6. Scan the numeric barcodes “1” and “2” from the “Digit Barcodes” section in Appendix.
7. Scan the **Save** barcode from the “Save/Cancel Barcodes” section in Appendix.
8. Scan the **Exit Setup** barcode.



@SETUPE0

**** Exit Setup**



@SETUPE1

Enter Setup

Check Character Verification

Check characters are optional for MSI-Plessey and can be added as the last one or two characters, which are calculated values used to verify the integrity of the data.

If the **Disable** option is enabled, the scanner transmits MSI-Plessey barcodes as is.



@MSICLK0

Disable



@MSICLK1

**** One Check Character, MOD10**



@MSICLK2

Two Check Characters, MOD10/MOD10



@MSICLK3

Two Check Characters, MOD10/MOD11



@SETUPE0

**** Exit Setup**



@SETUPE1

Enter Setup

Transmit Check Character



@MSITCK1

Transmit MSI-Plessey Check Character



@MSITCK0

**** Do Not Transmit MSI-Plessey Check Character**



If you select a check character algorithm and the **Do Not Transmit Check Character** option, MSI-Plessey barcodes with a length that is less than the configured minimum length after having the check character(s) excluded will not be decoded. (For example, when the **One Check Character, MOD10** and **Do Not Transmit Check Character** options are enabled and the minimum length is set to 4, MSI-Plessey barcodes with a total length of 4 characters including the check character cannot be read.)



@SETUPE0

**** Exit Setup**



@SETUPE1

Enter Setup

AIM 128

Restore Factory Defaults



@AIMDEF

Restore the Factory Defaults of AIM 128

Enable/Disable AIM 128



@AIMENA1

Enable AIM 128



@AIMENA0

**** Disable AIM 128**



If the scanner fails to identify AIM 128 barcodes, you may first try this solution by scanning the **Enter Setup** barcode and then **Enable AIM 128** barcode.



@SETUPE0

**** Exit Setup**



@SETUPE1

Enter Setup

Set Length Range for AIM 128

The scanner can be configured to only decode AIM 128 barcodes with lengths that fall between (inclusive) the minimum and maximum lengths. To accomplish it, you need to set the minimum and maximum lengths.



@AIMMIN

Set the Minimum Length (Default: 1)



@AIMMAX

Set the Maximum Length (Default: 48)



If minimum length is set to be greater than maximum length, the scanner only decodes AIM 128 barcodes with either the minimum or maximum length. If minimum length is same as maximum length, only AIM 128 barcodes with that length are to be decoded.



Set the scanner to decode AIM 128 barcodes containing between 8 and 12 characters:

1. Scan the **Enter Setup** barcode.
2. Scan the **Set the Minimum Length** barcode.
3. Scan the numeric barcode “8” from the “Digit Barcodes” section in Appendix.
4. Scan the **Save** barcode from the “Save/Cancel Barcodes” section in Appendix.
5. Scan the **Set the Maximum Length** barcode.
6. Scan the numeric barcodes “1” and “2” from the “Digit Barcodes” section in Appendix.
7. Scan the **Save** barcode from the “Save/Cancel Barcodes” section in Appendix.
8. Scan the **Exit Setup** barcode.



@SETUPE0

**** Exit Setup**



@SETUPE1

Enter Setup

ISBT 128

Restore Factory Defaults



@IBTDEF

Restore the Factory Defaults of ISBT 128

Enable/Disable ISBT 128



@IBTENA1

Enable ISBT 128



@IBTENA0

**** Disable ISBT 128**



If the scanner fails to identify ISBT 128 barcodes, you may first try this solution by scanning the **Enter Setup** barcode and then **Enable ISBT 128** barcode.



@SETUPE0

**** Exit Setup**



@SETUPE1

Enter Setup

Code 49

Restore Factory Defaults



@C49DEF

Restore the Factory Defaults of Code 49

Enable/Disable Code 49



@C49ENA1

Enable Code 49



@C49ENA0

**** Disable Code 49**



If the scanner fails to identify Code 49 barcodes, you may first try this solution by scanning the **Enter Setup** barcode and then **Enable Code 49** barcode.



@SETUPE0

**** Exit Setup**



Enter Setup

Set Length Range for Code 49

The scanner can be configured to only decode Code 49 barcodes with lengths that fall between (inclusive) the minimum and maximum lengths. To accomplish it, you need to set the minimum and maximum lengths.



Set the Minimum Length (Default: 1)



Set the Maximum Length (Default: 80)



If minimum length is set to be greater than maximum length, the scanner only decodes Code 49 barcodes with either the minimum or maximum length. If minimum length is same as maximum length, only Code 49 barcodes with that length are to be decoded.

Example

Set the scanner to decode Code 49 barcodes containing between 8 and 12 characters:

1. Scan the **Enter Setup** barcode.
2. Scan the **Set the Minimum Length** barcode.
3. Scan the numeric barcode “8” from the “Digit Barcodes” section in Appendix.
4. Scan the **Save** barcode from the “Save/Cancel Barcodes” section in Appendix.
5. Scan the **Set the Maximum Length** barcode.
6. Scan the numeric barcodes “1” and “2” from the “Digit Barcodes” section in Appendix.
7. Scan the **Save** barcode from the “Save/Cancel Barcodes” section in Appendix.
8. Scan the **Exit Setup** barcode.



**** Exit Setup**



@SETUPE1

Enter Setup

Code 16K

Restore Factory Defaults



@16KDEF

Restore the Factory Defaults of Code 16K

Enable/Disable Code 16K



@16KENA1

Enable Code 16K



@16KENA0

**** Disable Code 16K**



If the scanner fails to identify Code 16K barcodes, you may first try this solution by scanning the **Enter Setup** barcode and then **Enable Code 16K** barcode.



@SETUPE0

**** Exit Setup**



@SETUPE1

Enter Setup

Set Length Range for Code 16K

The scanner can be configured to only decode Code 16K barcodes with lengths that fall between (inclusive) the minimum and maximum lengths. To accomplish it, you need to set the minimum and maximum lengths.



@16KMIN

Set the Minimum Length (Default: 1)



@16KMAX

Set the Maximum Length (Default: 80)



If minimum length is set to be greater than maximum length, the scanner only decodes Code 16K barcodes with either the minimum or maximum length. If minimum length is same as maximum length, only Code 16K barcodes with that length are to be decoded.



Set the scanner to decode Code 16K barcodes containing between 8 and 12 characters:

1. Scan the **Enter Setup** barcode.
2. Scan the **Set the Minimum Length** barcode.
3. Scan the numeric barcode “8” from the “Digit Barcodes” section in Appendix.
4. Scan the **Save** barcode from the “Save/Cancel Barcodes” section in Appendix.
5. Scan the **Set the Maximum Length** barcode.
6. Scan the numeric barcodes “1” and “2” from the “Digit Barcodes” section in Appendix.
7. Scan the **Save** barcode from the “Save/Cancel Barcodes” section in Appendix.
8. Scan the **Exit Setup** barcode.



@SETUPE0

**** Exit Setup**



@SETUPE1

Enter Setup

PDF417

Restore Factory Defaults



@PDFDEF

Restore the Factory Defaults of PDF417

Enable/Disable PDF417



@PDFENA1

Enable PDF417



@PDFENA0

**** Disable PDF417**



If the scanner fails to identify PDF417 barcodes, you may first try this solution by scanning the **Enter Setup** barcode and then **Enable PDF417** barcode.



@SETUPE0

**** Exit Setup**



@SETUPE1

Enter Setup

Set Length Range for PDF417

The scanner can be configured to only decode PDF417 barcodes with lengths that fall between (inclusive) the minimum and maximum lengths. To accomplish it, you need to set the minimum and maximum lengths.



@PDFMIN

Set the Minimum Length (Default: 1)



@PDFMAX

Set the Maximum Length (Default: 2710)



Minimum length is not allowed to be greater than maximum length. If you only want to read PDF417 barcodes with a specific length, set both minimum and maximum lengths to be that desired length.

E
sample

Set the scanner to decode PDF417 barcodes containing between 8 and 12 characters:

1. Scan the **Enter Setup** barcode.
2. Scan the **Set the Minimum Length** barcode.
3. Scan the numeric barcode “8” from the “Digit Barcodes” section in Appendix.
4. Scan the **Save** barcode from the “Save/Cancel Barcodes” section in Appendix.
5. Scan the **Set the Maximum Length** barcode.
6. Scan the numeric barcodes “1” and “2” from the “Digit Barcodes” section in Appendix.
7. Scan the **Save** barcode from the “Save/Cancel Barcodes” section in Appendix.
8. Scan the **Exit Setup** barcode.



@SETUPE0

**** Exit Setup**



@SETUPE1

Enter Setup

PDF417 Twin Code

PDF417 twin code is 2 PDF417 barcodes paralleled vertically or horizontally. They must both be either regular or inverse barcodes. They must have similar specifications and be placed closely together.

There are 3 options for reading PDF417 twin codes:

- ◇ **Single PDF417 Only:** Read either PDF417 code.
- ◇ **Twin PDF417 Only:** Read both PDF417 codes.
- ◇ **Both Single & Twin:** Read both PDF417 codes. If successful, transmit as twin PDF417 only. Otherwise, try single PDF417 only.



@PDFDOU0

**** Single PDF417 Only**



@PDFDOU1

Twin PDF417 Only



@PDFDOU2

Both Single & Twin



@SETUPE0

**** Exit Setup**



@SETUPE1

Enter Setup

PDF417 Inverse

Regular barcode: Dark bars on a bright background.

Inverse barcode: Bright bars on a dark background.



@PDFINV0

**** Decode Regular PDF417 Barcodes Only**



@PDFINV1

Decode Inverse PDF417 Barcodes Only



@PDFINV2

Decode Both

Character Encoding



@PDFENC0

**** Default Character Encoding**



@PDFENC1

UTF-8



@PDFENC2

Automatically select UTF-8 or Code Page



@SETUPE0

**** Exit Setup**



@SETUPE1

Enter Setup

PDF417 ECI Output



@PDFECI0

Disable PDF417 ECI Output



@PDFECI1

**** Enable PDF417 ECI Output**



@SETUPE0

**** Exit Setup**



@SETUPE1

Enter Setup

Micro PDF417

Restore Factory Defaults



@MPDDEF

Restore the Factory Defaults of Micro PDF417

Enable/Disable Micro PDF417



@MPDENA1

Enable Micro PDF417



@MPDENA0

**** Disable Micro PDF417**



If the scanner fails to identify Micro PDF417 barcodes, you may first try this solution by scanning the **Enter Setup** barcode and then **Enable Micro PDF417** barcode.



@SETUPE0

**** Exit Setup**



@SETUPE1

Enter Setup

Set Length Range for Micro PDF417

The scanner can be configured to only decode Micro PDF417 barcodes with lengths that fall between (inclusive) the minimum and maximum lengths. To accomplish it, you need to set the minimum and maximum lengths.



@MPDMIN

Set the Minimum Length (Default: 1)



@MPDMAX

Set the Maximum Length (Default: 366)



Minimum length is not allowed to be greater than maximum length. If you only want to read Micro PDF417 barcodes with a specific length, set both minimum and maximum lengths to be that desired length.

Set the scanner to decode Micro PDF417 barcodes containing between 8 and 12 characters:

E
example

1. Scan the **Enter Setup** barcode.
2. Scan the **Set the Minimum Length** barcode.
3. Scan the numeric barcode “8” from the “Digit Barcodes” section in Appendix.
4. Scan the **Save** barcode from the “Save/Cancel Barcodes” section in Appendix.
5. Scan the **Set the Maximum Length** barcode.
6. Scan the numeric barcodes “1” and “2” from the “Digit Barcodes” section in Appendix.
7. Scan the **Save** barcode from the “Save/Cancel Barcodes” section in Appendix.
8. Scan the **Exit Setup** barcode.



@SETUPE0

**** Exit Setup**



@SETUPE1

Enter Setup

QR Code

Restore Factory Defaults



@QRCDEF

Restore the Factory Defaults of QR Code

Enable/Disable QR Code



@QRCENA1

**** Enable QR Code**



@QRCENA0

Disable QR Code



If the scanner fails to identify QR Code barcodes, you may first try this solution by scanning the **Enter Setup** barcode and then **Enable QR Code** barcode.



@SETUPE0

**** Exit Setup**



@SETUPE1

Enter Setup

Set Length Range for QR Code

The scanner can be configured to only decode QR Code barcodes with lengths that fall between (inclusive) the minimum and maximum lengths. To accomplish it, you need to set the minimum and maximum lengths.



@QRCPIN

Set the Minimum Length (Default: 1)



@QRCPAX

Set the Maximum Length (Default: 7089)



Minimum length is not allowed to be greater than maximum length. If you only want to read QR Code barcodes with a specific length, set both minimum and maximum lengths to be that desired length.

E
sample

Set the scanner to decode QR Code barcodes containing between 8 and 12 characters:

1. Scan the **Enter Setup** barcode.
2. Scan the **Set the Minimum Length** barcode.
3. Scan the numeric barcode “8” from the “Digit Barcodes” section in Appendix.
4. Scan the **Save** barcode from the “Save/Cancel Barcodes” section in Appendix.
5. Scan the **Set the Maximum Length** barcode.
6. Scan the numeric barcodes “1” and “2” from the “Digit Barcodes” section in Appendix.
7. Scan the **Save** barcode from the “Save/Cancel Barcodes” section in Appendix.
8. Scan the **Exit Setup** barcode.



@SETUPE0

**** Exit Setup**



@SETUPE1

Enter Setup

QR Twin Code

QR twin code is 2 QR barcodes paralleled vertically or horizontally. They must both be either regular or inverse barcodes. They must have similar specifications and be placed closely together.

There are 3 options for reading QR twin codes:

- ◇ **Single QR Only:** Read either QR code.
- ◇ **Twin QR Only:** Read both QR codes. Transmission sequence: left (upper) QR code followed by right (lower) QR code.
- ◇ **Both Single & Twin:** Read both QR codes. If successful, transmit as twin QR only. Otherwise, try single QR only.



@QRCDU0

**** Single QR Only**



@QRCDU1

Twin QR Only



@QRCDU2

Both Single & Twin



@SETUPE0

**** Exit Setup**



@SETUPE1

Enter Setup

QR Inverse

Regular barcode: Dark bars on a bright background.

Inverse barcode: Bright bars on a dark background.



@QRCINV0

**** Decode Regular QR Barcodes Only**



@QRCINV1

Decode Inverse QR Code Only



@QRCINV2

Decode Both

Character Encoding



@QRCENC0

**** Default Character Encoding**



@QRCENC1

UTF-8



@QRCENC3

Automatically select UTF-8 or Code Page



@SETUPE0

**** Exit Setup**



@SETUPE1

Enter Setup

QR ECI Output



@QRCEC10

Disable



@QRCEC11

****Enable**



@SETUPE0

**** Exit Setup**



@SETUPE1

Enter Setup

Micro QR Code

Restore Factory Defaults



@MQRDEF

Restore the Factory Defaults of Micro QR

Enable/Disable Micro QR



@MQRENA1

**** Enable Micro QR**



@MQRENA0

Disable Micro QR



If the scanner fails to identify Micro QR barcodes, you may first try this solution by scanning the **Enter Setup** barcode and then **Enable Micro QR** barcode.



@SETUPE0

**** Exit Setup**



@SETUPE1

Enter Setup

Set Length Range for Micro QR

The scanner can be configured to only decode Micro QR barcodes with lengths that fall between (inclusive) the minimum and maximum lengths. To accomplish it, you need to set the minimum and maximum lengths.



@MQRMIN

Set the Minimum Length (Default: 1)



@MQRMAX

Set the Maximum Length (Default: 35)



Minimum length is not allowed to be greater than maximum length. If you only want to read Micro QR barcodes with a specific length, set both minimum and maximum lengths to be that desired length.

E
sample

Set the scanner to decode Micro QR Code barcodes containing between 8 and 12 characters:

1. Scan the **Enter Setup** barcode.
2. Scan the **Set the Minimum Length** barcode.
3. Scan the numeric barcode “8” from the “Digit Barcodes” section in Appendix.
4. Scan the **Save** barcode from the “Save/Cancel Barcodes” section in Appendix.
5. Scan the **Set the Maximum Length** barcode.
6. Scan the numeric barcodes “1” and “2” from the “Digit Barcodes” section in Appendix.
7. Scan the **Save** barcode from the “Save/Cancel Barcodes” section in Appendix.
8. Scan the **Exit Setup** barcode.



@SETUPE0

**** Exit Setup**



@SETUPE1

Enter Setup

Aztec

Restore Factory Defaults



@AZTDEF

Restore the Factory Defaults of Aztec Code

Enable/Disable Aztec Code



@AZTENA1

Enable Aztec Code



@AZTENA0

**** Disable Aztec Code**



If the scanner fails to identify Aztec Code barcodes, you may first try this solution by scanning the **Enter Setup** barcode and then **Enable Aztec Code** barcode.



@SETUPE0

**** Exit Setup**



Enter Setup

Set Length Range for Aztec Code

The scanner can be configured to only decode Aztec barcodes with lengths that fall between (inclusive) the minimum and maximum lengths. To accomplish it, you need to set the minimum and maximum lengths.



Set the Minimum Length (Default: 1)



Set the Maximum Length (Default: 3832)



Minimum length is not allowed to be greater than maximum length. If you only want to read Aztec barcodes with a specific length, set both minimum and maximum lengths to be that desired length.

Set the scanner to decode Aztec barcodes containing between 8 and 12 characters:

E
xample

1. Scan the **Enter Setup** barcode.
2. Scan the **Set the Minimum Length** barcode.
3. Scan the numeric barcode “8” from the “Digit Barcodes” section in Appendix.
4. Scan the **Save** barcode from the “Save/Cancel Barcodes” section in Appendix.
5. Scan the **Set the Maximum Length** barcode.
6. Scan the numeric barcodes “1” and “2” from the “Digit Barcodes” section in Appendix.
7. Scan the **Save** barcode from the “Save/Cancel Barcodes” section in Appendix.
8. Scan the **Exit Setup** barcode.



**** Exit Setup**



@SETUPE1

Enter Setup

Read Multi-barcodes on an Image

There are three options:

- ◇ **Mode 1:** Read one barcode only.
- ◇ **Mode 2:** Read fixed number of barcodes only.
- ◇ **Mode 3:** Composite Reading. Read fixed number of barcodes first. If unsuccessful, read one barcode only.



@AZTMOD1

** Mode 1



@AZTMOD2

Mode 2



@AZTMOD3

Mode 3



@SETUPE0

** Exit Setup



@SETUPE1

Enter Setup

Set the Number of Barcodes



@AZTMUL1

** 1



@AZTMUL3

3



@AZTMUL5

5



@AZTMUL7

7



@AZTMUL2

2



@AZTMUL4

4



@AZTMUL6

6



@AZTMUL8

8



@SETUPE0

** Exit Setup



@SETUPE1

Enter Setup

Character Encoding



@AZTENC0

**** Default Character Encoding**



@AZTENC1

UTF-8



@AZTENC2

Automatically select UTF-8 or Code Page

Aztec ECI Output



@AZTECI0

**** Disable Aztec ECI
Output**



@AZTECI1

Enable Aztec ECI Output



@SETUPE0

**** Exit Setup**



@SETUPE1

Enter Setup

Data Matrix

Restore Factory Defaults



@DMCDEF

Restore the Factory Defaults of Data Matrix

Enable/Disable Data Matrix



@DMCENA1

**** Enable Data Matrix**



@DMCENA0

Disable Data Matrix



If the scanner fails to identify Data Matrix barcodes, you may first try this solution by scanning the **Enter Setup** barcode and then **Enable Data Matrix** barcode.



@SETUPE0

**** Exit Setup**



@SETUPE1

Enter Setup

Set Length Range for Data Matrix

The scanner can be configured to only decode Data Matrix barcodes with lengths that fall between (inclusive) the minimum and maximum lengths. To accomplish it, you need to set the minimum and maximum lengths.



@DMCMIN

Set the Minimum Length (Default: 1)



@DMCMAX

Set the Maximum Length (Default: 3116)



Minimum length is not allowed to be greater than maximum length. If you only want to read Data Matrix barcodes with a specific length, set both minimum and maximum lengths to be that desired length.

E *sample*

Set the scanner to decode Data Matrix barcodes containing between 8 and 12 characters:

1. Scan the **Enter Setup** barcode.
2. Scan the **Set the Minimum Length** barcode.
3. Scan the numeric barcode “8” from the “Digit Barcodes” section in Appendix.
4. Scan the **Save** barcode from the “Save/Cancel Barcodes” section in Appendix.
5. Scan the **Set the Maximum Length** barcode.
6. Scan the numeric barcodes “1” and “2” from the “Digit Barcodes” section in Appendix.
7. Scan the **Save** barcode from the “Save/Cancel Barcodes” section in Appendix.
8. Scan the **Exit Setup** barcode.



@SETUPE0

**** Exit Setup**



@SETUPE1

Enter Setup

Data Matrix Twin Code

Data Matrix twin code is 2 Data Matrix barcodes paralleled vertically or horizontally. They must both be either regular or inverse barcodes. They must have similar specifications and be placed closely together.

There are 3 options for reading Data Matrix twin codes:

- ❖ **Single Data Matrix Only:** Read either Data Matrix code.
- ❖ **Twin Data Matrix Only:** Read both Data Matrix codes. Transmission sequence: left (upper) Data Matrix code followed by right (lower) Data Matrix code.
- ❖ **Both Single & Twin:** Read both Data Matrix codes. If successful, transmit as twin Data Matrix only. Otherwise, try single Data Matrix only.



@DMCDOU0

Single Data Matrix Only



@DMCDOU1

Twin Data Matrix Only



@DMCDOU2

**** Both Single & Twin**



@SETUPE0

**** Exit Setup**



@SETUPE1

Enter Setup

Rectangular Barcode

Data Matrix has two formats:

Square barcodes having the same amount of modules in length and width: 10*10, 12*12.... 144*144.

Rectangular barcodes having different amounts of models in length and width: 6*16, 6*14...14*22.



@DMCREC1

**** Enable Rectangular Barcode**



@DMCREC0

Disable Rectangular Barcode

Data Matrix Inverse

Regular barcode: Dark bars on a bright background.

Inverse barcode: Bright bars on a dark background.



@DMCINV0

Decode Regular Data Matrix Barcodes Only



@DMCINV1

Decode Inverse Data Matrix Barcodes Only



@DMCINV2

**** Decode Both**



@SETUPE0

**** Exit Setup**



@SETUPE1

Enter Setup

Character Encoding



@DMCENC0

**** Default Character Encoding**



@DMCENC2

Automatically select UTF-8 or Code Page



@DMCENC1

UTF-8

Data Matrix ECI Output



@DMCEC10

Disable Data Matrix ECI Output



@DMCEC1

**** Enable Data Matrix ECI Output**



@SETUPE0

**** Exit Setup**



@SETUPE1

Enter Setup

Maxicode

Restore Factory Defaults



@MXCDEF

Restore the Factory Defaults of Maxicode

Enable/Disable Maxicode



@MXCENA1

Enable Maxicode



@MXCENA0

**** Disable Maxicode**



If the scanner fails to identify Maxicode barcodes, you may first try this solution by scanning the **Enter Setup** barcode and then **Enable Maxicode** barcode.



@SETUPE0

**** Exit Setup**



@SETUPE1

Enter Setup

Set Length Range for Maxicode

The scanner can be configured to only decode Maxicode barcodes with lengths that fall between (inclusive) the minimum and maximum lengths. To accomplish it, you need to set the minimum and maximum lengths.



@MXCMIN

Set the Minimum Length (Default: 1)



@MXCMAX

Set the Maximum Length (Default:150)



Minimum length is not allowed to be greater than maximum length. If you only want to read Maxicode barcodes with a specific length, set both minimum and maximum lengths to be that desired length.

E *xample*

Set the scanner to decode Maxicode barcodes containing between 8 and 12 characters:

1. Scan the **Enter Setup** barcode.
2. Scan the **Set the Minimum Length** barcode.
3. Scan the numeric barcode “8” from the “Digit Barcodes” section in Appendix.
4. Scan the **Save** barcode from the “Save/Cancel Barcodes” section in Appendix.
5. Scan the **Set the Maximum Length** barcode.
6. Scan the numeric barcodes “1” and “2” from the “Digit Barcodes” section in Appendix.
7. Scan the **Save** barcode from the “Save/Cancel Barcodes” section in Appendix.
8. Scan the **Exit Setup** barcode.



@SETUPE0

**** Exit Setup**



@SETUPE1

Enter Setup

Chinese Sensible Code

Restore Factory Defaults



@CSCDEF

Restore the Factory Defaults of Chinese Sensible Code

Enable/Disable Chinese Sensible Code



@CSCENA1

Enable Chinese Sensible Code



@CSCENA0

**** Disable Chinese Sensible Code**



If the scanner fails to identify Chinese Sensible Code barcodes, you may first try this solution by scanning the **Enter Setup** barcode and then **Enable Chinese Sensible Code** barcode.



@SETUPE0

**** Exit Setup**



Enter Setup

Set Length Range for Chinese Sensible Code

The scanner can be configured to only decode Chinese Sensible Code barcodes with lengths that fall between (inclusive) the minimum and maximum lengths. To accomplish it, you need to set the minimum and maximum lengths.



Set the Minimum Length (Default: 1)



Set the Maximum Length (Default: 7827)



Minimum length is not allowed to be greater than maximum length. If you only want to read Chinese Sensible Code barcodes with a specific length, set both minimum and maximum lengths to be that desired length.

E *sample*

Set the scanner to decode Chinese Sensible Code barcodes containing between 8 and 12 characters:

1. Scan the **Enter Setup** barcode.
2. Scan the **Set the Minimum Length** barcode.
3. Scan the numeric barcode “8” from the “Digit Barcodes” section in Appendix.
4. Scan the **Save** barcode from the “Save/Cancel Barcodes” section in Appendix.
5. Scan the **Set the Maximum Length** barcode.
6. Scan the numeric barcodes “1” and “2” from the “Digit Barcodes” section in Appendix.
7. Scan the **Save** barcode from the “Save/Cancel Barcodes” section in Appendix.
8. Scan the **Exit Setup** barcode.



**** Exit Setup**



@SETUPE1

Enter Setup

Chinese Sensible Twin Code

Chinese Sensible twin code is 2 Chinese Sensible barcodes paralleled vertically or horizontally. They must both be either regular or inverse barcodes. They must have similar specifications and be placed closely together.

There are 3 options for reading Chinese Sensible twin codes:

- ◇ **Single Chinese Sensible Code Only:** Read either Chinese Sensible code.
- ◇ **Twin Chinese Sensible Code Only:** Read both Chinese Sensible codes. Transmission sequence: left (upper) Chinese Sensible code followed by right (lower) Chinese Sensible code.
- ◇ **Both Single & Twin:** Read both Chinese Sensible codes. If successful, transmit as twin Chinese Sensible Code only. Otherwise, try single Chinese Sensible Code only.



@CSCDOU0

**** Single Chinese Sensible Code Only**



@CSCDOU1

Twin Chinese Sensible Code Only



@CSCDOU2

Both Single & Twin



@SETUPE0

**** Exit Setup**



@SETUPE1

Enter Setup

Chinese Sensible Code Inverse

Regular barcode: Dark bars on a bright background.

Inverse barcode: Bright bars on a dark background.



@CSCINV0

**** Decode Regular Chinese Sensible Barcodes Only**



@CSCINV1

Decode Inverse Chinese Sensible Barcodes Only



@CSCINV2

Decode Both



@SETUPE0

**** Exit Setup**



@SETUPE1

Enter Setup

GM Code

Restore Factory Defaults



@GMCDEF

Restore the Factory Defaults of GM

Enable/Disable GM



@GMCENA1

Enable GM



@GMCENA0

**** Disable GM**



If the scanner fails to identify GM barcodes, you may first try this solution by scanning the **Enter Setup** barcode and then **Enable GM** barcode.



@SETUPE0

**** Exit Setup**



@SETUPE1

Enter Setup

Set Length Range for GM

The scanner can be configured to only decode GM barcodes with lengths that fall between (inclusive) the minimum and maximum lengths. To accomplish it, you need to set the minimum and maximum lengths.



@GMCMIN

Set the Minimum Length (Default: 1)



@GMCMAX

Set the Maximum Length (Default: 2751)



Minimum length is not allowed to be greater than maximum length. If you only want to read GM barcodes with a specific length, set both minimum and maximum lengths to be that desired length.



Set the scanner to decode GM barcodes containing between 8 and 12 characters:

1. Scan the **Enter Setup** barcode.
2. Scan the **Set the Minimum Length** barcode.
3. Scan the numeric barcode “8” from the “Digit Barcodes” section in Appendix.
4. Scan the **Save** barcode from the “Save/Cancel Barcodes” section in Appendix.
5. Scan the **Set the Maximum Length** barcode.
6. Scan the numeric barcodes “1” and “2” from the “Digit Barcodes” section in Appendix.
7. Scan the **Save** barcode from the “Save/Cancel Barcodes” section in Appendix.
8. Scan the **Exit Setup** barcode.



@SETUPE0

**** Exit Setup**



@SETUPE1

Enter Setup

Code One

Restore Factory Defaults



@ONEDEF

Restore the Factory Defaults of Code One

Enable/Disable Code One



@ONEENA1

Enable Code One



@ONEENA0

**** Disable Code One**



If the scanner fails to identify Code One barcodes, you may first try this solution by scanning the **Enter Setup** barcode and then **Enable Code One** barcode.



@SETUPE0

**** Exit Setup**



Enter Setup

Set Length Range for Code One

The scanner can be configured to only decode Code One barcodes with lengths that fall between (inclusive) the minimum and maximum lengths. To accomplish it, you need to set the minimum and maximum lengths.



Set the Minimum Length (Default: 1)



Set the Maximum Length (Default: 3550)



Minimum length is not allowed to be greater than maximum length. If you only want to read Code One barcodes with a specific length, set both minimum and maximum lengths to be that desired length.

Set the scanner to decode Code One barcodes containing between 8 and 12 characters:

E
sample

1. Scan the **Enter Setup** barcode.
2. Scan the **Set the Minimum Length** barcode.
3. Scan the numeric barcode “8” from the “Digit Barcodes” section in Appendix.
4. Scan the **Save** barcode from the “Save/Cancel Barcodes” section in Appendix.
5. Scan the **Set the Maximum Length** barcode.
6. Scan the numeric barcodes “1” and “2” from the “Digit Barcodes” section in Appendix.
7. Scan the **Save** barcode from the “Save/Cancel Barcodes” section in Appendix.
8. Scan the **Exit Setup** barcode.



**** Exit Setup**



@SETUPE1

Enter Setup

USPS Postnet

Restore Factory Defaults



@PNTDEF

Restore the Factory Defaults of USPS Postnet

Enable/Disable USPS Postnet



@PNTENA1

Enable USPS Postnet



@PNTENA0

**** Disable USPS Postnet**



If the scanner fails to identify USPS Postnet barcodes, you may first try this solution by scanning the **Enter Setup** barcode and then **Enable USPS Postnet** barcode.

Transmit Check Character



@PNTCHK1

Do Not Transmit USPS Postnet Check Character



@PNTCHK2

**** Transmit USPS Postnet Check Character**



@SETUPE0

**** Exit Setup**



@SETUPE1

Enter Setup

USPS Intelligent Mail

Restore Factory Defaults



@ILGDEF

Restore the Factory Defaults of USPS Intelligent Mail

Enable/Disable USPS Intelligent Mail



@ILGENA1

Enable USPS Intelligent Mail



@ILGENA0

**** Disable USPS Intelligent Mail**



If the scanner fails to identify USPS Intelligent Mail barcodes, you may first try this solution by scanning the **Enter Setup** barcode and then **Enable USPS Intelligent Mail** barcode.



@SETUPE0

**** Exit Setup**



@SETUPE1

Enter Setup

Royal Mail

Restore Factory Defaults



@ROYDEF

Restore the Factory Defaults of Royal Mail

Enable/Disable Royal Mail



@ROYENA1

Enable Royal Mail



@ROYENA0

**** Disable Royal Mail**



If the scanner fails to identify Royal Mail barcodes, you may first try this solution by scanning the **Enter Setup** barcode and then **Enable Royal Mail** barcode.



@SETUPE0

**** Exit Setup**



@SETUPE1

Enter Setup

USPS Planet

Restore Factory Defaults



@PLADEF

Restore the Factory Defaults of USPS Planet

Enable/Disable USPS Planet



@PLAENA1

Enable USPS Planet



@PLAENA0

**** Disable USPS Planet**



If the scanner fails to identify USPS Planet barcodes, you may first try this solution by scanning the **Enter Setup** barcode and then **Enable USPS Planet** barcode.

Transmit Check Character



@PLACHK1

Do Not Transmit USPS Planet Check Character



@PLACHK2

**** Transmit USPS Planet Check Character**



@SETUPE0

**** Exit Setup**



@SETUPE1

Enter Setup

KIX Post

Restore Factory Defaults



@KIXDEF

Restore the Factory Defaults of KIX Post

Enable/Disable KIX Post



@KIXENA1

Enable KIX Post



@KIXENA0

**** Disable KIX Post**



If the scanner fails to identify KIX Post barcodes, you may first try this solution by scanning the **Enter Setup** barcode and then **Enable KIX Post** barcode.



@SETUPE0

**** Exit Setup**



@SETUPE1

Enter Setup

Australian Postal

Restore Factory Defaults



@APLDEF

Restore the Factory Defaults of Australian Postal

Enable/Disable Australian Postal



@APLENA1

Enable Australian Postal



@APLENA0

**** Disable Australian Postal**



If the scanner fails to identify Australian Postal barcodes, you may first try this solution by scanning the **Enter Setup** barcode and then **Enable Australian Postal** barcode.



@SETUPE0

**** Exit Setup**



@SETUPE1

Enter Setup

Japan Post

Restore Factory Defaults



@JPPDEF

**** Restore the Factory Defaults of Japan Post**

Enable/Disable Japan Post

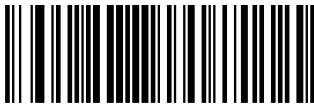

@JPPENA1

Enable Japan Post



@JPPENA0

**** Disable Japan Post**



@SETUPE0

**** Exit Setup**



@SETUPE1

Enter Setup

Passport OCR

Restore Factory Defaults



@PASDEF

Restore the Factory Defaults of Passport OCR

Enable/Disable Passport OCR



@PASENA1

Enable Passport OCR



@PASENA0

**** Disable Passport OCR**



If the scanner fails to identify Passport OCR barcodes, you may first try this solution by scanning the **Enter Setup** barcode and then **Enable Passport OCR** barcode.



@SETUPE0

**** Exit Setup**

Chapter 7 Data Formatter

Introduction

You may use the Data Formatter to modify the scanner's output. For example, you can use the Data Formatter to insert characters at certain points in barcode data or to suppress/ replace/ send certain characters in barcode data as it is scanned. Normally, when you scan a barcode, it gets outputted automatically; however, when you create a format, you must use a "send" command (see the "Send Commands" section in this chapter) within the format programming to output data. Multiple data formats can be programmed into the scanner. The maximum size of all data formats created is 2048 characters. By default, the data formatter is disabled. Enable it when required. If you have changed data format settings, and wish to clear all formats and return to the factory defaults, scan the **Default Data Format** barcode below.



Default Data Format

Add a Data Format

Data format is used to edit barcode data. When you create a data format, you must select one of the four labels (Format_0, Format_1, Format_2 and Format_3) for your data format, specify the application scope of data format (such as barcode type and data length) and include formatter commands. Multiple data formats may be created using the same label. When scanned data does not match your data format requirements, you will hear the non-match error beep (if the non-match error beep is ON).

There are two methods to program a data format: Programming with barcodes and programming with serial commands.

Programming with Barcodes

The following explains how to program a data format by scanning the specific barcodes. Scanning any irrelevant barcode or failing to follow the setting procedure will result in programming failure. To find the alphanumeric barcodes needed to create a data format, see the "Digit Barcodes" section in Appendix.

Step 1: Scan the **Enter Setup** barcode.



Enter Setup

Step 2: Scan the **Add Data Format** barcode.



Add Data Format

Step 3: Select a label (Format_0 or Format_1 or Format_2 or Format_3).

Scan a numeric barcode **0** or **1** or **2** or **3** to label this data format Format_0 or Format_1 or Format_2 or Format_3.

Step 4: Select formatter command type.

Specify what type of formatter commands will be used. Scan a numeric barcode “6” to select formatter command type 6. (See the “Formatter Command Type 6” section in this chapter for more information)

Step 5: Set interface type

Scan **999** for any interface type.

Step 6: Set Symbology ID Number

Refer to the “Symbology ID Number” section in Appendix and find the ID number of the symbology to which you want to apply the data format. Scan three numeric barcodes for the symbology ID number. If you wish to create a data format for all symbologies, scan **999**.

Step 7: Set barcode data length

Specify what length of data will be acceptable for this symbology. Scan the four numeric barcodes that represent the data length. 9999 is a universal number, indicating all lengths. For example, 32 characters should be entered as 0032.

Step 8: Enter formatter command

Refer to the “Formatter Command Type 6” section in this chapter. Scan the alphanumeric barcodes that represent the command you need to edit data. For example, when a command is F141, you should scan F141.

Step 9: Scan the **Save** barcode from the “Save/Cancel Barcodes” section in Appendix to save your data format.



**** Exit Setup**



Example: Program a Format_0 data format using formatter command type 6, Code 128 containing 10 characters applicable, send all characters followed by "A".

- | | |
|---|---|
| 1. Scan the Enter Setup barcode | Enter the Setup mode |
| 2. Scan the Add Data Format barcode | Add a data format |
| 3. Scan the 0 barcode | Select Format_0 as the label |
| 4. Scan the 6 barcode | Select formatter command type 6 |
| 5. Scan the 9 barcode three times | All interface types applicable |
| 6. Scan the barcodes 002 | Only Code 128 applicable |
| 7. Scan the barcodes 0010 | Only a length of 10 characters applicable |
| 8. Scan the alphanumeric barcodes F141 | Send all characters followed by "A" (HEX: 41) |
| 9. Scan the Save barcode | Save the data format |

To streamline the programming process, you may as well generate a batch barcode by inputting the command (e.g. **@DFMADD069990020010F141;**) used to create a data format. See the "Use Batch Barcode" section in Chapter 9 to learn how to put a batch barcode into use.

When creating multiple data formats sharing a label, the formats are separated from each other by a vertical bar (|) in the batch command, e.g. **@DFMADD069990029999F141|069990039999F142|169990049999F143;**.





@SETUPE1
Enter Setup

Programming with Serial Commands

A data format can also be created by serial commands (HEX) sent from the host device. **All commands must be entered in uppercase letters.**

The syntax consists of the following elements:

Prefix: "~<SOH>0000" (HEX: **7E 01 30 30 30 30**), 6 characters.

Storage type: "@" (HEX: **40**) or "#" (HEX: **23**), 1 character. "@" means permanent setting which will not be lost by removing power from the scanner or rebooting it; "#" means temporary setting which will be lost by removing power from the scanner or rebooting it.

Add Data Format Command: "DFMADD" (HEX: **44 46 4D 41 44 44**), 6 characters.

Data format label: "0" (HEX: **30**) or "1" (HEX: **31**) or "2" (HEX: **32**) or "3" (HEX: **33**), 1 character. "0", "1", "2" and "3" represent Format_0, Format_1, Format_2 and Format_3 respectively.

Formatter command type: "6" (HEX: **36**), 1 character.

Interface type: "999" (HEX: **39 39 39**), 3 characters.

Symbology ID Number: The ID number of the symbology to which you want to apply the data format, 3 characters. 999 indicates all symbologies.

Data length: The length of data that will be acceptable for this symbology, 4 characters. 9999 indicates all lengths. For example, 32 characters should be entered as 0032.

Formatter commands: The command string used to edit data. For more information, see the "Formatter Command Type 6" section in this chapter.

Suffix: ";<ETX>" (HEX: **3B 03**), 2 characters.

Example: Program a Format_0 data format using formatter command type 6, Code 128 containing 10 characters applicable, send all characters followed by "A".

Enter: **7E 01 30 30 30 30 40 44 46 4D 41 44 44 30 36 39 39 39 30 30 33 39 39 39 39 46 31 34 31 3B 03**
(~<SOH>0000@DFMADD069990020010F141;<ETX>)

Response: **02 01 30 30 30 30 40 44 46 4D 41 44 44 30 36 39 39 39 30 30 33 39 39 39 39 46 31 34 31 06 3B 03**
(<STX><SOH>0000@DFMADD069990020010F141<ACK>;<ETX>)

When creating multiple data formats sharing a label, the formats are separated from each other by a vertical bar (|) in the serial command.

Example: ~<SOH>0000@DFMADD069990020010F141|069990039999F142|069990049999F143;<ETX>



** Exit Setup



Enable/Disable Data Formatter

When Data Formatter is disabled, the barcode data is outputted to the host as read, including prefixes and suffixes.



**** Disable Data Formatter**

You may wish to require the data to conform to a data format you have created. The following settings can be applied to your data format:

Enable Data Formatter, Required, Keep Prefix/Suffix: Scanned data that meets your data format requirements is modified accordingly and gets outputted along with prefixes and suffixes (if prefix and suffix are enabled). Any data that does not match your data format requirements generates an error beep (if Non-Match Error Beep is turned ON) and the data in that barcode is not transmitted.

Enable Data Formatter, Required, Drop Prefix/Suffix: Scanned data that meets your data format requirements is modified accordingly and gets outputted without prefixes and suffixes (even if prefix and suffix are enabled). Any data that does not match your data format requirements generates an error beep (if Non-Match Error Beep is turned ON) and the data in that barcode is not transmitted.

Enable Data Formatter, Not Required, Keep Prefix/Suffix: Scanned data that meets your data format requirements is modified accordingly and gets outputted along with prefixes and suffixes (if prefix and suffix are enabled). Barcode data that does not match your data format requirements is transmitted as read along with prefixes and suffixes (if prefix and suffix are enabled).

Enable Data Formatter, Not Required, Drop Prefix/Suffix: Scanned data that meets your data format requirements is modified accordingly and gets outputted without prefixes and suffixes (even if prefix and suffix are enabled). Barcode data that does not match your data format requirements is transmitted as read along with prefixes and suffixes (if prefix and suffix are enabled).





Enter Setup



@DFMENA1

Enable Data Formatter, Required, Keep Prefix/Suffix



@DFMENA2

Enable Data Formatter, Required, Drop Prefix/Suffix



@DFMENA3

Enable Data Formatter, Not Required, Keep Prefix/Suffix



@DFMENA4

Enable Data Formatter, Not Required, Drop Prefix/Suffix

Non-Match Error Beep

If Non-Match Error Beep is turned ON, the scanner generates an error beep when a barcode is encountered that does not match your required data format.



@DFMTON0

Non-Match Error Beep Off



@DFMTON1

**** Non-Match Error Beep On**



**** Exit Setup**



@SETUPE1

Enter Setup

Data Format Selection

After enabling the Data Formatter, you can select a data format you want to use by scanning the appropriate barcode below.



@DFMUSE0

**** Format_0**



@DFMUSE2

Format_2



@DFMUSE1

Format_1



@DFMUSE3

Format_3



@SETUPE0

**** Exit Setup**



@SETUPE1
Enter Setup

Change Data Format for a Single Scan

You can switch between data formats for a single scan. The next barcode is scanned using the data format selected here, then reverts to the format you have selected above.

For example, you may have set your scanner to use the data format you saved as Format_3. You can switch to Format_1 for a single trigger pull by scanning the **Single Scan – Format_1** barcode below. The next barcode that is scanned uses Format_1, then reverts back to Format_3.

Note: This setting will be lost by removing power from the scanner, or turning off/ rebooting the device.



@DFMSIN0
Single Scan – Format_0



@DFMSIN2
Single Scan – Format_2



@DFMSIN1
Single Scan – Format_1



@DFMSIN3
Single Scan – Format_3



@SETUPE0
**** Exit Setup**



Clear Data Format

There are two methods to remove data format created from your scanner:

Delete one data format: Scan the **Clear One** barcode, a numeric barcode (0-3) and the **Save** barcode. For example, to delete Format_2, you should scan the **Clear One** barcode, the **2** barcode and the **Save** barcode

Delete all data formats: Scan the **Clear All** barcode.



Query Data Formats

You may scan the appropriate barcode below to get the information of data format(s) created by you or preset by manufacturer. For instance, if you have added Format_0 as per the example in the "Add a Data Format" section in this chapter, scanning the **Query Current Data Formats** barcode, you will get the result: **Data Format0:069990020010F141;**





@SETUPE1
Enter Setup

Formatter Command Type 6

When working with the Data Formatter, a virtual cursor is moved along your input data string. The following commands are used to both move this cursor to different positions, and to select, replace, and insert data into the final output. For the hex value of ASCII characters involved in the commands, refer to the "ASCII Table" in Appendix.

Send Commands

F1 Send all characters

Syntax=F1xx (xx: The insert character's hex value)

Include in the output message all of the characters from the input message, starting from current cursor position, followed by an insert character.

F2 Send a number of characters

Syntax=F2nxx (nn: The numeric value (00-99) for the number of characters; xx: The insert character's hex value)

Include in the output message a number of characters followed by an insert character. Start from the current cursor position and continue for "nn" characters or through the last character in the input message, followed by character "xx."

F2 Example: Send a number of characters



Send the first 10 characters from the barcode above, followed by a carriage return.

Command string: **F2100D**

F2 is the "Send a number of characters" command

10 is the number of characters to send

0D is the hex value for a CR

The data is output as: **1234567890**

<CR>



@SETUPE0
** Exit Setup



@SETUPE1

Enter Setup

F3 Send all characters up to a particular character

Syntax=F3ssxx (ss: The particular character's hex value; xx: The insert character's hex value)

Include in the output message all characters from the input message, starting with the character at the current cursor position and continuing to, but not including, the particular character "ss," followed by character "xx." The cursor is moved forward to the "ss" character.

F3 Example: Send all characters up to a particular character



1234567890ABCDEFGHIJ

Using the barcode above, send all characters up to but not including "D," followed by a carriage return.

Command string: **F3440D**

F3 is the "Send all characters up to a particular character" command

44 is the hex value for a "D"

0D is the hex value for a CR

The data is output as: **1234567890ABC**

<CR>



@SETUPE0

**** Exit Setup**



@SETUPE1
Enter Setup

B9 Send all characters up to a particular string

Syntax=B9nnnns...s (nnnn: The length of the particular string; s...s: The hex value of each character in the particular string)

Include in the output message all characters from the input message, starting with the character at the current cursor position and continuing to, but not including, the particular string “s...s.” The cursor is moved forward to the beginning of the “s...s” string.

B9 Example: Send all characters up to a particular string



Using the barcode above, send all characters up to but not including “AB.”

Command string: **B900024142**

B9 is the “Send all characters up to a particular string” command

0002 is the length of the particular string (2 characters)

41 is the hex value for a “A” (character in the string)

42 is the hex value for a “B” (character in the string)

The data is output as: **1234567890**

E9 Send all but the last characters

Syntax=E9nn (nn: The numeric value (00-99) for the number of characters that will not be sent at the end of the message)

Include in the output message all but the last “nn” characters, starting from the current cursor position. The cursor is moved forward to one position past the last input message character included.

F4 Insert a character multiple times

Syntax=F4xxnn (xx: The insert character’s hex value; nn: The numeric value (00-99) for the number of times it should be sent)

Send “xx” character “nn” times in the output message, leaving the cursor in the current position.



@SETUPE0
**** Exit Setup**



@SETUPE1

Enter Setup

E9 and F4 Example: Send all but the last characters, followed by 2 tabs



Send all characters except for the last 8 from the barcode above, followed by 2 tabs.

Command string: **E908F40902**

E9 is the “Send all but the last characters” command

08 is the number of characters at the end to ignore

F4 is the “Insert a character multiple times” command

09 is the hex value for a horizontal tab

02 is the number of time the tab character is sent

The data is output as: **1234567890AB<tab><tab>**

B3 Insert symbology name

Insert the name of the barcode’s symbology in the output message, without moving the cursor.

B4 Insert barcode length

Insert the barcode’s length in the output message, without moving the cursor. The length is expressed as a numeric string and does not include leading zeros.



@SETUPE0

** Exit Setup



Enter Setup

B3 and B4 Example: Insert the symbology name and length



Send the symbology name and length before the barcode data from the barcode above. Break up these insertions with spaces. End with a carriage return.

Command string: **B3F42001B4F42001F10D**

B3 is the “Insert symbology name” command

F4 is the “Insert a character multiple times” command

20 is the hex value for a space

01 is the number of time the space character is sent

B4 is the “Insert barcode length” command

F4 is the “Insert a character multiple times” command

20 is the hex value for a space

01 is the number of time the space character is sent

F1 is the “Send all characters” command

0D is the hex value for a CR

The data is output as: **Code128 20 1234567890ABCDEFGHIJ**

<CR>

Move Commands

F5 Move the cursor forward a number of characters

Syntax=F5nn (nn: The numeric value (00-99) for the number of characters the cursor should be moved ahead)

Move the cursor ahead “nn” characters from current cursor position.



**** Exit Setup**



@SETUPE1

Enter Setup

F5 Example: Move the cursor forward and send the data



Move the cursor forward 3 characters, then send the rest of the barcode data from the barcode above. End with a carriage return.

Command string: **F503F10D**

F5 is the “Move the cursor forward a number of characters” command

03 is the number of characters to move the cursor

F1 is the “Send all characters” command

0D is the hex value for a CR

The data is output as: **4567890ABCDEFGHIJ**

<CR>

F6 Move the cursor backward a number of characters

Syntax=F6nn (nn: The numeric value (00-99) for the number of characters the cursor should be moved back)

Move the cursor back “nn” characters from current cursor position.

F7 Move the cursor to the beginning

Syntax=F7

Move the cursor to the first character in the input message.

EA Move the cursor to the end

Syntax=EA

Move the cursor to the last character in the input message.



@SETUPE0

** Exit Setup



@SETUPE1
Enter Setup

Search Commands

F8 Search forward for a character

Syntax = F8xx (xx: The search character's hex value)

Search the input message forward for "xx" character from the current cursor position, leaving the cursor pointing to the "xx" character.

F8 Example: Send barcode data that starts after a particular character



Search for the letter "D" in barcodes and send all the data that follows, including the "D". Using the barcode above:

Command string: **F844F10D**

F8 is the "Search forward for a character" command

44 is the hex value for "D"

F1 is the "Send all characters" command

0D is the hex value for a CR

The data is output as: **DEFGHIJ**

<CR>

F9 Search backward for a character

Syntax = F9xx (xx: The search character's hex value)

Search the input message backward for "xx" character from the current cursor position, leaving the cursor pointing to the "xx" character.



@SETUPE0
**** Exit Setup**



@SETUPE1

Enter Setup

B0 Search forward for a string

Syntax=B0nnnnS (nnnn: The string length (up to 9999); S: The ASCII hex value of each character in the string)

Search forward for “S” string from the current cursor position, leaving cursor pointing to “S” string. For example, B0000454657374 will search forward for the first occurrence of the 4-character string “Test.”

B0 Example: Send barcode data that starts after a string of characters



Search for the letters “FGH” in barcodes and send all the data that follows, including “FGH.” Using the barcode above:

Command string: **B00003464748F10D**

B0 is the “Search forward for a string” command

0003 is the string length (3 characters)

46 is the hex value for “F”

47 is the hex value for “G”

48 is the hex value for “H”

F1 is the “Send all characters” command

0D is the hex value for a CR

The data is output as: **FGHIJ**

<CR>

B1 Search backward for a string

Syntax=B1nnnnS (nnnn: The string length (up to 9999); S: The ASCII hex value of each character in the string)

Search backward for “S” string from the current cursor position, leaving cursor pointing to “S” string. For example, B1000454657374 will search backward for the first occurrence of the 4-character string “Test.”



@SETUPE0

** Exit Setup



@SETUPE1
Enter Setup

E6 Search forward for a non-matching character

Syntax=E6xx (xx: The search character's hex value)

Search the input message forward for the first non-"xx" character from the current cursor position, leaving the cursor pointing to the non-"xx" character.

E6 Example: Remove zeros at the beginning of barcode data



0000123abc

This example shows a barcode that has been zero filled. You may want to ignore the zeros and send all the data that follows. E6 searches forward for the first character that is not zero, then sends all the data after, followed by a carriage return. Using the barcode above:

Command string: **E630F10D**

E6 is the "Search forward for a non-matching character" command

30 is the hex value for 0

F1 is the "Send all characters" command

0D is the hex value for a CR

The data is output as: **123abc<CR>**

E7 Search backward for a non-matching character

Syntax=E7xx(xx: The search character's hex value)

Search the input message backward for the first non-"xx" character from the current cursor position, leaving the cursor pointing to the non-"xx" character.



@SETUPE0
**** Exit Setup**



@SETUPE1

Enter Setup

Comparison Command

B2 string comparison

Syntax= B2nnnnSS1SSn (nnnn: the length of character string, SS1- SSn: the hex value of character string)

The comparison starts from the right side of the current cursor position, and the cursor moves nnnn characters to the right. If the string within the cursor movement range is equal to SS1SSn, the instruction continues to execute; otherwise, it exits.

B2 example: Send data after the specified string of character



Test123456

The above barcode starts with the "Test" string, and requires the content of the Test string to be sent, and finally a carriage return.

Command string: B2000454657374F10D

B2 is the comparison of the character string" command

0004 is the string length (4 characters)

54 is the hex value for T

65 is the hex value for e

73 is the hex value for s

74 is the hex value for t

F1 is the "Send all characters" command

0D is the hex value of carriage return

The data is output as 123456<CR>

EC Check if the character to the right of the cursor is number

This command takes no parameters. If the right side of the cursor is a non-numeric, the current command is exited, otherwise execution continues.

EC example: Send barcode data that starts with number characters



0000123abc

The above barcode starts with number characters, requires to send barcode data, and finally sends a carriage return

Command string: ECF10D

EC is the "Check if the character to the right of the cursor is a number" command

F1 is the "Send All Characters" command

0D is the hex value for CR



@SETUPE0

** Exit Setup



Enter Setup

The data is output as 0000123abc<CR>

ED Check if the character to the right of the cursor is non-numeric

This command takes no parameters. If the right side of the cursor is a number, the current command is exited, otherwise execution continues.

ED example: Send barcode data that starts with non-numeric characters



Test123456

The above barcode starts with non-numeric characters, requires to send barcode data, and finally sends a carriage return

Command string: EDF10D

EC is the "Check if the character to the right of the cursor is a number" command

F1 is the "Send All Characters" command

0D is the hex value of carriage return

The data is output as Test123456 <CR>

FE Character Comparison

Syntax = FExx (xx is the hex value of the character)

If the character to the right of the current cursor position is xx, execution continues; otherwise exit.

FE example: The example is a barcode that starts with the character "1" and send the first 6 bytes of the barcode.



1234567890ABCDEFGHIJ

The above barcode starts with the character "1", and requires to send the character "1" and the next 5 characters

Command string: FE31F7F2060D

FE is the "Character Compare" command

31 is the hex of the character "1"

F7 is the "Move cursor to starting position" command

F2 is the "Send several characters" command

06 is the "Send character length"

0D is the hex value of carriage return

The data is output as 123456 <CR>

Miscellaneous Commands

FB Suppress characters



**** Exit Setup**



@SETUPE1

Enter Setup

Syntax=FBnnxyy..zz (nn: The numeric value (00-15) for the number of suppressed characters; xyy..zz: The hex value of the characters to be suppressed)

Suppress all occurrences of up to 15 different characters, starting at the current cursor position, as the cursor is advanced by other commands.

FB Example: Remove spaces in barcode data



This example shows a barcode that has spaces in the data. You may want to remove the spaces before sending the data. Using the barcode above:

Command string: **FB0120F10D**

FB is the "Suppress characters" command

01 is the number of the characters to be

suppressed 20 is the hex value for a space

F1 is the "Send all characters" command

0D is the hex value for a CR

The data is output as: **34567890**

<CR>

E4 Replace characters

Syntax= E4nnxx₁xx₂yy₁yy₂...ZZ₁ZZ₂(nn: The total count of the number of characters (characters to be replaced plus replacement characters; xx₁: The characters to be replaced, xx₂: The replacement characters, continuing through zz₁ and zz₂)

Replace up to 15 characters in the output message, without moving the cursor.



@SETUPE0

** Exit Setup



Enter Setup

E4 Example: Replace zeros with CRs in barcode data



If the barcode has characters that the host application does not want included, you can use the E4 command to replace those characters with something else. In this example, you will replace the zeros in the barcode above with carriage returns.

Command string: **E402300DF10D**

E4 is the "Replace characters" command

02 is the total count of characters to be replaced, plus the replacement characters (0 is replaced by CR, so total characters=2) 30 is the hex value for 0

0D is the hex value for a CR (the character that will replace the 0)

F1 is the "Send all characters" command

0D is the hex value for a CR

The data is output as: **1234**

5678

ABC

<CR>



**** Exit Setup**



@SETUPE1

Enter Setup

BA Replace a string with another

Syntax = BAnnNN₁SS₁NN₂SS₂

nn: The count of replacements to be made, if nn=00 or nn>=the number of occurrences of a string to be replaced, then replace all occurrences of that string.

NN₁: The length of the string to be replaced, NN₁>0.

SS₁: The ASCII hex value of each character in the string to be replaced.

NN₂: The length of replacement string, NN₂>=0. To replace string "SS₁" with NUL (i.e. delete string "SS₁"), you should set NN₂ to 00 and leave out SS₂.

SS₂: The ASCII hex value of each character in the replacement string.

From the current cursor position, search forward for the occurrence of "SS₁" string (of length "NN₁") and replace the string with "SS₂" string (of length "NN₂") in the output message until every "SS₁" string is replaced or the count of replacements made reaches "nn" times, without moving the cursor.

BA Example: Replace "23"s with "ABC"s in barcode data



cd123abc23bc12ab232

If the barcode has a string of characters that the host application does not want included, you can use the BA command to replace the string with something else. In this example, you will replace the "23"s in the barcode above with "ABC"s.

Command string: **BA0002323303414243F100**

BA is the "Replace a string with another" command

00 is the count of replacements to be made, 00 means to replace all occurrences of that string

02 is the length of the string to be replaced



@SETUPE0

** Exit Setup



Enter Setup

32 is the hex value for 2 (character in the string to be replaced)

33 is the hex value for 3 (character in the string to be replaced)

03 is the length of the replacement string

41 is the hex value for A (character in the replacement string)

42 is the hex value for B (character in the replacement string)

43 is the hex value for C (character in the replacement string)

F1 is the "Send all characters" command

00 is the hex value for a NUL

The data is output as: **cd1ABCabcABCbc12abABC2**

BA Example: Remove only the first occurrence of "23"s in barcode data

If the barcode has a string of characters that the host application wants removed, you can use the BA command to replace the string with NUL. In this example, you will remove the first occurrence of "23" in the barcode above.

Command string: **BA0102323300F100**

BA is the "Replace a string with another" command

01 is the count of replacements to be made

02 is the length of the string to be replaced

32 is the hex value for 2 (character in the string to be replaced)

33 is the hex value for 3 (character in the string to be replaced)

00 is the length of the replacement string, 00 means to replace the string to be replaced with NUL

F1 is the "Send all characters" command

00 is the hex value for a NUL

The data is output as: **cd1abc23bc12ab232**



**** Exit Setup**



EF Insert a delay

Syntax=EFnnnn (nnnn: The delay in 5ms increments, up to 9999)

Inserts a delay of up to 49,995 milliseconds (in multiples of 5), starting from the current cursor position. This command can only be used with USB HID Keyboard.

EF Example: Insert a delay of 1s between the 5th and 6th character

Send the first 5 characters in a barcode, wait for 1s, then send the rest of the barcode data.

Command string: **F20500EF0200E900**

F2 is the “Send a number of characters” command

05 is the number of characters to send

00 is the hex value for a Null character

EF is the “Insert a delay” command

0200 is the delay value (5msX200=1000ms=1s)

E9 is the “Send all but the last characters” command

00 is the number of characters that will not be sent at the end of the message





@SETUPE1
Enter Setup

B5 Insert key strokes

Syntax=B5nnssxx (nn: The number of keys pressed (without key modifiers); ss: the key modifier from the table below; xx: the key number from the “Unicode Key Maps” in Appendix.)

Insert a key stroke or combination of key strokes. Key strokes are dependent on your keyboard (see the “Unicode Key Maps” in Appendix). This command can only be used with USB HID Keyboard.

Key Modifiers	
No Key Modifier	00
Shift Left	01
Shift Right	02
Alt Left	04
Alt Right	08
Control Left	10
Control Right	20

For example, B501001F inserts an “a” on a U.S. style keyboard. B5 = the command, 01 = number of keys pressed (without the key modifier), 00 is No Key Modifier, and 1F is the “a” key. If an “A” were to be inserted, B501011F or B501021F would be entered.

If there are two keystrokes, the syntax would change from Syntax=B5nnssxx for one keystroke to Syntax=B5nnssxxssxx. An example that would insert “aA” is as follows: B502001F011F.

Note: Key modifiers can be added together when needed. Example: Shift Left + Alt Left + Control Left =15.

EE Loop execution

Syntax= EEEnnCMD1CMDm (the length of command to be loop execution; CMD1CMDm: the command string to be looped). Starting loop execution from the right of the current cursor station until the cursor moves to the end of the barcode or the conditions for search, replace, and segmentation are not met

EE example: insert a null character and delay 1 second after every 3 characters.



Command string: EE12F20300EF0200F100

EE is the “Loop execution” command.



@SETUPE0
**** Exit Setup**



@SETUPE1

Enter Setup

12 is the length of command to be loop execution. Decimal

(F20300EF0200: command string to be loop execution)

F2 is "Send several characters" command

03 is send the length of command

00 is null character

EF is "Delay time between characters" command

0200 is the delay time

F1 is "Send all characters" command

00 is null character

The result is output as 123{1s delay} 456 {1s delay} 789 {1s delay} 0AB {1s delay} CDE {1s delay} FGH {1s delay} IJ



@SETUPE0

**** Exit Setup**



@SETUPE1
Enter Setup

B8 abandon some type of barcode

This command has no parameters. It is generally used in combination with the comparison command and must be after all commands.

B8 Example: Prevent the output of barcodes beginning with T, and other barcodes are normally output.



Test123456

Two command strings are required to implement this function:

The first command string: FE54B8

FE is the "Character Comparison" command

54 is the hexadecimal of the character "T"

B8 is "Block" command

The second command string: F100

F1 is "Send All Characters" command

00 is null character

The result is output as: The above example barcode has no output, and other barcodes are output normally.



@SETUPE0
**** Exit Setup**

Chapter 8 Prefix & Suffix

Introduction

A 1D barcode could contain digits, letters, symbols, etc. A 2D barcode could contain more data, such as Chinese characters and other multi-byte characters. However, in real applications, they do not and should not have all information we need, such as barcode type, data acquisition time and delimiter, in order to keep the barcodes short and flexible.

Prefix and suffix are how to fulfill the needs mentioned above. They can be added, removed and modified while the original barcode data remains intact.



Barcode processing procedure:

1. Edit data with Data Formatter
2. Append prefix/suffix
3. Pack data
4. Append terminating character



@SETUPE1
Enter Setup

Global Settings

Enable/Disable All Prefixes/Suffixes

Disable All Prefixes/Suffixes: Transmit barcode data with no prefix/suffix.

Enable All Prefixes/Suffixes: Allow to append Code ID prefix, AIM ID prefix, Custom prefix/suffix and terminating character to the barcode data before the transmission.



@APSENA0
**** Disable All Prefixes/Suffixes**



@APSENA1
Enable All Prefixes/Suffixes

Prefix Sequence



@PRESEQ0
**** Code ID+ Custom +AIM ID**



@PRESEQ1
Custom + Code ID + AIM ID



@SETUPE0
**** Exit Setup**



@SETUPE1

Enter Setup

Custom Prefix

Enable/Disable Custom Prefix

If custom prefix is enabled, you are allowed to append to the data a user-defined prefix that cannot exceed 10 characters. For example, if the custom prefix is “AB” and the barcode data is “123”, the Host will receive “AB123”.



@CPRENA0

** Disable Custom Prefix



@CPRENA1

Enable Custom Prefix

Set Custom Prefix

To set a custom prefix, scan the **Set Custom Prefix** barcode then the numeric barcodes corresponding to the hexadecimal value of a desired prefix then the **Save** barcode.

Note: A custom prefix cannot exceed 10 characters.



@CPRSET

Set Custom Prefix

E
xample

Set the custom prefix to “CODE” (HEX: 0x43/0x4F/0x44/0x45):

1. Scan the **Enter Setup** barcode.
2. Scan the **Set Custom Prefix** barcode.
3. Scan the numeric barcodes “4”, “3”, “4”, “F”, “4”, “4”, “4” and “5” from the “Digit Barcodes” section in Appendix.
4. Scan the **Save** barcode from the “Save/Cancel Barcodes” section in Appendix.
5. Scan the **Enable Custom Prefix** barcode.
6. Scan the **Exit Setup** barcode.



@SETUPE0

** Exit Setup



@SETUPE1

Enter Setup

AIM ID Prefix

AIM (Automatic Identification Manufacturers) ID defines symbology identifier (For the details, see the “AIM ID Table” section in Appendix). If AIM ID prefix is enabled, the scanner will add the symbology identifier before the scanned data after decoding.



@AIDENA0

**** Disable AIM ID Prefix**



@AIDENA1

Enable AIM ID Prefix



AIM ID is not user programmable.



@SETUPE0

**** Exit Setup**



@SETUPE1

Enter Setup

Code ID Prefix

Code ID can also be used to identify barcode type. Unlike AIM ID, Code ID is user programmable. Code ID can only consist of one or two English letters.



@CIDENA0

**** Disable Code ID Prefix**



@CIDENA1

Enable Code ID Prefix

Restore All Default Code IDs

For the information of default Code IDs, see the “Code ID Table” section in Appendix.



@CIDDEF

Restore All Default Code IDs

Modify Code ID

See the examples below to learn how to modify a Code ID and restore the default Code IDs of all symbologies.



@SETUPE0

**** Exit Setup**



@SETUPE1

Enter Setup

E *xample*

Modify PDF417 Code ID to be “p” (HEX: 0x70):

1. Scan the **Enter Setup** barcode.
2. Scan the **Modify PDF417 Code ID** barcode.
3. Scan the numeric barcodes “7” and “0” from the “Digit Barcodes” section in Appendix.
4. Scan the **Save** barcode from the “Save/Cancel Barcodes” section in Appendix.
5. Scan the **Exit Setup** barcode.

Restore the default Code IDs of all symbologies:

1. Scan the **Enter Setup** barcode.
2. Scan the **Restore All Default Code IDs** barcode.
3. Scan the **Exit Setup** barcode.



@SETUPE0

**** Exit Setup**



@SETUPE1

Enter Setup

1D symbologies:



@CID002

Modify Code 128 Code ID



@CID003

Modify GS1-128 Code ID



@CID004

Modify EAN-8 Code ID



@CID005

Modify EAN-13 Code ID



@CID006

Modify UPC-E Code ID



@CID007

Modify UPC-A Code ID



@CID008

Modify Interleaved 2 of 5 Code ID



@SETUPE0

**** Exit Setup**



@SETUPE1

Enter Setup



@CID010

Modify ITF-6 Code ID



@CID013

Modify Code 39 Code ID



@CID017

Modify Code 93 Code ID



@CID020

Modify AIM 128 Code ID



@CID009

Modify ITF-14 Code ID



@CID011

Modify Matrix 2 of 5 Code ID



@CID015

Modify Codabar Code ID



@CID019

Modify China Post 25 Code ID



@SETUPE0

**** Exit Setup**



@SETUPE1

Enter Setup



@CID022

Modify COOP 25



@CID021

Modify ISBT 128 Code ID



@CID023

Modify ISSN Code ID



@CID024

Modify ISBN Code ID



@CID025

Modify Industrial 25 Code ID



@CID026

Modify Standard 25 Code ID



@CID027

Modify Plessey Code ID



@CID028

Modify Code 11 Code ID



@CID029

Modify MSI-Plessey Code ID



@SETUPE0

**** Exit Setup**



@SETUPE1

Enter Setup



@CID031

Modify GS1 Databar Code ID



@CID133

Modify Code 16K Code ID



@CID030

Modify GS1 Composite Code ID



@CID132

Modify Code 49 Code ID



@SETUPE0

**** Exit Setup**



@SETUPE1

Enter Setup

2D symbologies:



@CID032

Modify PDF417 Code ID



@CID034

Modify Aztec Code ID



@CID036

Modify Maxicode Code ID



@CID041

Modify GM Code ID



@CID033

Modify QR Code ID



@CID035

Modify Data Matrix Code ID



@CID039

Modify Chinese Sensible Code ID



@SETUPE0

**** Exit Setup**



@SETUPE1

Enter Setup



@CID043

Modify Micro QR Code ID



@CID042

Modify Micro PDF417 Code ID



@CID048

Modify Code One Code ID



@SETUPE0

**** Exit Setup**



@SETUPE1

Enter Setup

Postal symbologies:



@CID096

Modify USPS Postnet Code ID



@CID097

Modify USPS Intelligent Mail Code ID



@CID098

Modify Royal Mail Code ID



@CID099

Modify USPS Planet Code ID



@CID100

Modify KIX Post Code ID



@CID101

Modify Australian Postal Code ID



@CID102

Modify Japan Post Code ID



@SETUPE0

**** Exit Setup**



@SETUPE1

Enter Setup

Custom Suffix

Enable/Disable Custom Suffix

If custom suffix is enabled, you are allowed to append to the data a user-defined suffix that cannot exceed 10 characters. For example, if the custom suffix is “AB” and the barcode data is “123”, the Host will receive “123AB”.



@CSUENA0

** Disable Custom Suffix



@CSUENA1

Enable Custom Suffix

Set Custom Suffix

To set a custom suffix, scan the **Set Custom Suffix** barcode then the numeric barcodes corresponding to the hexadecimal value of a desired suffix then the **Save** barcode.

Note: A custom suffix cannot exceed 10 characters.



@CSUSET

Set Custom Suffix

E
sample

Set the custom suffix to “CODE” (HEX: 0x43/0x4F/0x44/0x45):

1. Scan the **Enter Setup** barcode.
2. Scan the **Set Custom Suffix** barcode.
3. Scan the numeric barcodes “4”, “3”, “4”, “F”, “4”, “4”, “4” and “5” from the “Digit Barcodes” section in Appendix.
4. Scan the **Save** barcode from the “Save/Cancel Barcodes” section in Appendix.
5. Scan the **Enable Custom Suffix** barcode.
6. Scan the **Exit Setup** barcode.



@SETUPE0

** Exit Setup



@SETUPE1

Enter Setup

Data Packing

Introduction

Data packing is designed for a specific group of users who want to have the data packed before transmission. Data packing influences data format, so it is advised to disable this feature when it is not required.

Data Packing Options

Disable Data Packing: Transmit decoded data in raw format (unpacked).

Enable Data Packing, Format 1: Transmit decoded data with the packet format 1 defined below.

Packet format 1: [STX + ATTR + LEN] + [AL_TYPE + DATA] + [LRC]

STX: 0x02

ATTR: 0x00

LEN: Barcode data length is expressed in 2 bytes ranging from 0x0000 (0) to 0xFFFF (65535).

AL_TYPE: 0x36

DATA: Raw barcode data.

LRC: Check digit.

LRC calculation algorithm: computation sequence: 0xFF+LEN+AL_TYPE+DATA; computation method is XOR, byte by byte.

Enable Data Packing, Format 2: Transmit decoded data with the packet format 2 defined below.

Packet format 2: [STX + ATTR + LEN] + [AL_TYPE] + [Symbology_ID + DATA] + [LRC]

STX: 0x02

ATTR: 0x00

LEN: Barcode data length is expressed in 2 bytes ranging from 0x0000 (0) to 0xFFFF (65535).

AL_TYPE: 0x3B

Symbology_ID: The ID number of symbology, 1 byte.

DATA: Raw barcode data.

LRC: Check digit.

LRC calculation algorithm: computation sequence: 0xFF+LEN+AL_TYPE+Symbology_ID+DATA; computation method is XOR, byte by byte.



@SETUPE0

** Exit Setup



@SETUPE1

Enter Setup



@PACKAG0

**** Disable Data Packing**



@PACKAG2

Enable Data Packing, Format 2



@PACKAG1

Enable Data Packing, Format 1



@SETUPE0

**** Exit Setup**



@SETUPE1

Enter Setup

Terminating Character Suffix

Enable/Disable Terminating Character Suffix

A terminating character such as carriage return (CR) or carriage return/line feed pair (CRLF) can only be used to mark the end of data, which means nothing can be added after it.



@TSUENA0

Disable Terminating Character Suffix



@TSUENA1

**** Enable Terminating Character Suffix**

Set Terminating Character Suffix

To set a terminating character suffix, scan the **Set Terminating Character Suffix** barcode then the numeric barcodes corresponding to the hexadecimal value of a desired terminating character then the **Save** barcode.

Note: A terminating character suffix cannot exceed 2 characters.



@TSUSET

Set Terminating Character Suffix



@TSUSET0D

****Set Terminating Character to CR (0x0D)**



@TSUSET0D0A

Set Terminating Character to CRLF (0x0D,0x0A)



@SETUPE0

**** Exit Setup**



@SETUPE1

Enter Setup

E *sample*

Set the terminating character suffix to 0x0A:

1. Scan the **Enter Setup** barcode.
2. Scan the **Set Terminating Character Suffix** barcode.
3. Scan the numeric barcodes "0" and "A" from the "Digit Barcodes" section in Appendix.
4. Scan the **Save** barcode from the "Save/Cancel Barcodes" section in Appendix.
5. Scan the **Enable Terminating Character Suffix** barcode.
6. Scan the **Exit Setup** barcode.



@SETUPE0

**** Exit Setup**

Chapter 9 Batch Programming

Introduction

Batch programming enables users to integrate a batch of commands into a single batch barcode.

Listed below are batch programming rules:

1. Command format: Command + Parameter Value.
2. Each command is terminated by a semicolon (;). Note that there is no space between a command and its terminator semicolon.
3. Use the barcode generator software to generate a 2D batch barcode.

Example: Create a batch barcode for **Illumination On, Sense Mode, Decode Session Timeout = 2s, Disable Interleaved**
2 of 5:

1. Input the commands:

```
@ILLSCN1;SCNMOD2;ORTSET2000;I25ENA0;
```

2. Generate a batch barcode.

When setting up a scanner with the above configuration, scan the **Enable Batch Barcode** barcode and then the batch barcode generated.



@BATCHS

Enable Batch Barcode



@SETUPE1

Enter Setup

Create a Batch Command

A batch command may contain a number of individual commands each of which is terminated by a semicolon (;).

For more information, refer to the “Use of Programming Command” section in Chapter 3.

Create a Batch Barcode

Batch barcodes can be produced in the format of PDF417, QR Code or Data Matrix.

Example: Create a batch barcode for **Illumination On, Sense Mode, Decode Session Timeout = 2s, Disable Interleaved 2 of 5**:

1. Input the following commands:

```
@ILLSCN1;SCNMOD2;ORTSET2000;I25ENA0;
```

2. Generate a PDF417 batch barcode.



@SETUPE0

** Exit Setup



Use Batch Barcode

To put a batch barcode into use, scan the following barcodes. (Use the example above.)



Enter Setup



Enable Batch Barcode



Batch Barcode



Exit Setup



Appendix

Digit Barcodes

0~9





@DIGIT6

6



@DIGIT8

8



@DIGIT7

7



@DIGIT9

9

A~F



@DIGITA

A



@DIGITC

C



@DIGITE

E



@DIGITB

B



@DIGITD

D



@DIGITF

F

Save/Cancel Barcodes

After reading numeric barcode(s), you need to scan the **Save** barcode to save the data. If you scan the wrong digit(s), you can either scan the **Cancel** barcode and then start the configuration all over again, or scan the **Delete the Last Digit** barcode and then the correct digit, or scan the **Delete All Digits** barcode and then the digits you want.

For instance, after reading the **Maximum Length** barcode and numeric barcodes “1”, “2” and “3”, you scan:

- ❖ **Delete the Last Digit:** The last digit “3” will be removed.
- ❖ **Delete All Digits:** All digits “123” will be removed.
- ❖ **Cancel:** The maximum length configuration will be cancelled. And the scanner is still in the setup mode.



Factory Defaults Table

Parameter	Factory Default	Remark
System Settings		
Barcode Programming	Disabled (Exit Setup)	
Programming Barcode Data	Do not transmit	
Illumination	On	
Aiming	Normal	
Good Read LED	On	
Good Read LED Duration	Short (20ms)	
Power On Beep	On	
Good Read Beep	On	
Good Read Beep Duration	Long (120ms)	
Good Read Beep Frequency	High (4200Hz)	
Good Read Beep Volume	Loud	
Scan Mode	Sense Mode	
Decode Session Timeout	3,000ms.	1-3,600,000ms; 0: Infinite
Image Stabilization Timeout (Sense Mode)	200ms	0-3,000ms
Image Decoding Timeout	3,000ms	1-3,000ms
Reread Timeout	Disabled	
	600ms	1-3,600,000ms
Good Read Delay	Disabled	
	500ms	
Sensitivity	Medium Sensitivity	
Surround GS1 AI's with Parentheses	Do Not Surround GS1 AI's with Parentheses	
Transmit GS1 Check character	Enable	
Infrared Sensitivity (Sense Mode)	High	
Trigger Selection (Sense Mode)	Both	
Trigger Commands	Disabled	
Scanning Preference	Normal Mode	
Read Barcode	On	
Decode Area	Whole Area Decoding	
Specify Decoding Area	40% top, 60% bottom, 40% left, 60% right	
Image Flipping	Do Not Flip	

Exposure Parameter Limit	Off	
Maximum Exposure Time	14000	
Minimum Exposure Time	50	
Gain Parameter Limit	Off	
Maximum Gain Value	49	
Minimum Gain Value	1	
Smart Mode	On	
Bad Read Message	Off	
	NG	1-7 characters
Default Interface	USB HID Keyboard	
RS-232 Interface		
Baud Rate	9600	
Parity Check	None	
Data Bits	8	
Stop Bits	1	
Hardware Auto Flow Control	Disabled	
USB Interface		
USB Country Keyboard	US keyboard	USB HID Keyboard
Beep on Unknown Character	Off	USB HID Keyboard
Emulate ALT+Keypad	Off	USB HID Keyboard
Code Page	Code Page 1252 (West European Latin)	USB HID Keyboard
Unicode Encoding	Off	USB HID Keyboard
Emulate Keypad with Leading Zero	On	USB HID Keyboard
Function Key Mapping	Disable	USB HID Keyboard
Inter-Keystroke Delay	No Delay	USB HID Keyboard
Caps Lock	Off	USB HID Keyboard
Convert Case	No Case Conversion	USB HID Keyboard
Emulate Numeric Keypad 1	Off	USB HID Keyboard
Emulate Numeric Keypad 2	Off	USB HID Keyboard
Fast Mode	Off	USB HID Keyboard
Polling Rate	4ms	USB HID Keyboard
Symbologies		
Global Settings		
1D Twin Code	Single 1D Code Only	
Code 128		

Code 128	Enabled	
Maximum Length	48	
Minimum Length	1	
EAN-8		
EAN-8	Enabled	
Check Character	Transmit	
2-Digit Add-On Code	Disabled	
5-Digit Add-On Code	Disabled	
Convert EAN-8 to EAN-13	Disabled	
EAN-13		
EAN-13	Enabled	
Check Character	Transmit	
2-Digit Add-On Code	Disabled	
5-Digit Add-On Code	Disabled	
Add-On Code	Not Required	
EAN-13 Beginning with 290 Add-On Code Required	Do Not Require Add-On Code	
EAN-13 Beginning with 378/379 Add-On Code Required	Do Not Require Add-On Code	
EAN-13 Beginning with 414/419 Add-On Code Required	Do Not Require Add-On Code	
EAN-13 Beginning with 434/439 Add-On Code Required	Do Not Require Add-On Code	
EAN-13 Beginning with 977 Add-On Code Required	Do Not Require Add-On Code	
EAN-13 Beginning with 978 Add-On Code Required	Do Not Require Add-On Code	
EAN-13 Beginning with 979 Add-On Code Required	Do Not Require Add-On Code	
UPC-E		
UPC-E	Enabled	
UPC-E0	Enabled	
UPC-E1	Disabled	
Check Character	Transmit	
2-Digit Add-On Code	Disabled	
5-Digit Add-On Code	Disabled	

Transmit Preamble Character	System Character	
Convert UPC-E to UPC-A	Disabled	
UPC-A		
UPC-A	Enabled	
Check Character	Transmit	
2-Digit Add-On Code	Disabled	
5-Digit Add-On Code	Disabled	
Transmit Preamble Character	No Preamble	
Coupon		
UPC-A/EAN-13 with Extended Coupon Code	Disabled	
Coupon GS1 DataBar Output	Disabled	
Interleaved 2 of 5		
Interleaved 2 of 5	Disabled	
Maximum Length	80	
Minimum Length	6	No less than 4
Check Character Verification	Disabled	
Febraban		
Febraban	Disabled	
Transmit Delay per Character	Disabled	
	70ms	
Transmit Delay per 12 Characters	Disabled	
	500ms	
ITF-14		
ITF-14	Disabled	
ITF-6		
ITF-6	Disabled	
Matrix 2 of 5		
Matrix 2 of 5	Disabled	
Maximum Length	80	
Minimum Length	4	No less than 4
Check Character Verification	Disabled	
Code 39		
Code 39	Enabled	
Maximum Length	48	
Minimum Length	1	

Check Character Verification	Disabled	
Start/Stop Character	Do not transmit	
Code 39 Full ASCII	Disabled	
Code 32 Pharmaceutical (PARAF)	Disabled	
Code 32 Prefix	Disabled	
Code 32 Start/Stop Character	Do not transmit	
Code 32 Check Character	Do not transmit	
Codabar		
Codabar	Disabled	
Maximum Length	60	
Minimum Length	2	
Check Character Verification	Disabled	
Start/Stop Character	Do not transmit	
	ABCD/ABCD	
Code 93		
Code 93	Disabled	
Maximum Length	48	
Minimum Length	1	No less than 1
Check Character Verification	Do Not Transmit Check Character After Verification	
China Post 25		
China Post 25	Disabled	
Maximum Length	48	
Minimum Length	1	
Check Character Verification	Disabled	
GS1-128 (UCC/EAN-128)		
GS1-128	Enabled	
Maximum Length	48	
Minimum Length	1	
GS1 Databar		
GS1 Databar	Disabled	
Application Identifier "01"	Do Not Transmit	
EAN-UCC Composite		
GS1 Composite	Disabled	
UPC/EAN Composite	Disabled	
Code 11		

Code 11	Disabled	
Maximum Length	48	
Minimum Length	4	No less than 4
Check Character Verification	One Check Character, MOD11	
Check Character	Transmit	
ISBN		
ISBN	Disabled	
Set ISBN Format	ISBN-10	
ISSN		
ISSN	Disabled	
Industrial 25		
Industrial 25	Disabled	
Maximum Length	48	
Minimum Length	6	No less than 4
Check Character Verification	Disabled	
Standard 25		
Standard 25	Disabled	
Maximum Length	48	
Minimum Length	6	No less than 4
Check Character Verification	Disabled	
Plessey		
Plessey	Disabled	
Maximum Length	48	
Minimum Length	4	No less than 4
Check Character Verification	Disabled	
MSI-Plessey		
MSI-Plessey	Disabled	
Maximum Length	48	
Minimum Length	4	No less than 4
Check Character Verification	One Check Character, MOD10	
Check Character	Do Not Transmit	
AIM 128		
AIM 128	Disabled	
Maximum Length	48	
Minimum Length	1	
ISBT 128		

ISBT 128	Disabled	
Code 49		
Code 49	Disabled	
Maximum Length	80	
Minimum Length	1	
Code 16K		
Code 16K	Disabled	
Maximum Length	80	
Minimum Length	1	
PDF417		
PDF417	Disabled	
Maximum Length	2710	
Minimum Length	1	
PDF417 Twin Code	Single PDF417 Only	
PDF417 Inverse	Decode Regular PDF417 Barcodes Only	
Character Encoding	Default Character Encoding	
PDF417 ECI Output	Enabled	
Micro PDF417		
Micro PDF417	Disabled	
Maximum Length	366	
Minimum Length	1	
QR Code		
QR Code	Enabled	
Maximum Length	7089	
Minimum Length	1	
QR Twin Code	Single QR Only	
QR Inverse	Decode Regular QR Barcodes Only	
Character Encoding	Default Character Encoding	
QR ECI Output	Enabled	
Micro QR Code		
Micro QR	Enabled	
Maximum Length	35	
Minimum Length	1	
Aztec		
Aztec Code	Disabled	
Maximum Length	3832	

Minimum Length	1	
Read Multi-barcodes on an Image	Mode 1	
Set the Number of Barcodes	1	
Character Encoding	Default Character Encoding	
Aztec ECI Output	Disabled	
Data Matrix		
Data Matrix	Enabled	
Maximum Length	3116	
Minimum Length	1	
Data Matrix Twin Code	Both Single and Twin	
Rectangular Barcode	Enabled	
Data Matrix Inverse	Decode Both	
Character Encoding	Default Character Encoding	
Data Matrix ECI Output	Enabled	
Maxicode		
Maxicode	Disabled	
Maximum Length	150	
Minimum Length	1	
Chinese Sensible Code		
Chinese Sensible Code	Disabled	
Maximum Length	7827	
Minimum Length	1	
Chinese Sensible Twin Code	Single Chinese Sensible Code Only	
Chinese Sensible Code Inverse	Decode Regular Chinese Sensible Barcodes Only	
GM Code		
GM	Disabled	
Maximum Length	2571	
Minimum Length	1	
Code One		
Code One	Disabled	
Maximum Length	3550	
Minimum Length	1	
USPS Postnet		
USPS Postnet	Disabled	
Check Character	Transmit	
USPS Intelligent Mail		

USPS Intelligent Mail	Disabled	
Royal Mail		
Royal Mail	Disabled	
USPS Planet		
USPS Planet	Disabled	
Check Character	Transmit	
KIX Post		
KIX Post	Disabled	
Australian Postal		
Australian Postal	Disabled	
Japan Post		
Japan Post	Disabled	
Passport OCR		
Passport OCR	Disabled	
Data Formatter		
Data Formatter	Disabled	
Non-Match Error Beep	On	
Data Format Selection	Format_0	
Prefix & Suffix		
All Prefixes/Suffixes	Disabled	
Prefix Sequence	Code ID+ Custom +AIM ID	
Custom Prefix	Disabled	
AIM ID Prefix	Disabled	
Code ID Prefix	Disabled	
Custom Suffix	Disabled	
Data Packing	Disable Data Packing	
Terminating Character Suffix	Enable <CR> (0x0D)	

AIM ID Table

Symbology	AIM ID	Possible AIM ID Modifiers (m)
Code 128	JC0	
GS1-128 (UCC/EAN-128)	JC1	
EAN-8	JE4	
EAN-8 with Addon	JE3	
EAN-13	JE0	
EAN-13 with Addon	JE3	
UPC-E	JE0	
UPC-E with Addon	JE3	
UPC-A	JE0	
UPC-A with Addon	JE3	
Interleaved 2 of 5, Febraban	JIm	0, 1, 3
ITF-14	JIm	1, 3
ITF-6	JIm	1, 3
Matrix 2 of 5	JX0	
Code 39	JAm	0, 1, 3, 4, 5, 7
Codabar	JFm	0, 2, 4
Code 93	JG0	
China Post 25	JX0	
AIM 128	JC2	
ISBT 128	JC4	
ISSN	JX0	
ISBN	JX0	
Industrial 25	JS0	
Standard 25	JR0	
Plessey	JP0	
Code 11	JHm	0, 1, 3
MSI Plessey	JMm	0, 1
GS1 Composite	Jem	0-3
GS1 Databar (RSS)	Je0	
Code 49	JT0	
Code 16K	JK0	

Symbology	AIM ID	Possible AIM ID Modifiers (m)
PDF417]Lm	0-2
QR Code]Qm	0-6
Aztec]zm	0-9, A-C
Data Matrix]dm	0-6
Maxicode]Um	0-3
Chinese Sensible Code]X0	
GM]gm	(0~9)
Micro PDF417]L0	
Micro QR]Q1	
Code One]X0	
USPS Postnet]X0	
USPS Intelligent Mail]X0	
Royal Mail]X0	
USPS Planet]X0	
KIX Post]X0	
Australian Postal]X0	
Japan Post]X0	
Passport OCR]o2	

Note: “m” represents the AIM modifier character. Refer to ISO/IEC 15424:2008 Information technology – Automatic identification and data capture techniques – Data Carrier Identifiers (including Symbology Identifiers) for AIM modifier character details.

Code ID Table

Symbology	Code ID
Code 128	j
GS1-128 (UCC/EAN-128)	j
EAN-8	d
EAN-13	d
UPC-E	c
UPC-A	c
Interleaved 2 of 5, Febraban	e
ITF-14	e
ITF-6	e
Matrix 2 of 5	v
Code 39	b
Codabar	a
Code 93	i
China Post 25	X
AIM 128	X
ISBT 128	X
ISSN	g
ISBN	B
Industrial 25	l
Standard 25	f
Plessey	n
Code 11	H
MSI Plessey	m
GS1 Composite	y
GS1 Databar (RSS)	R
Code 49	X
Code 16K	X
PDF417	r
QR Code	s
Aztec	z
Data Matrix	u

Symbology	Code ID
MaxiCode	x
Chinese Sensible Code	h
GM Code	x
Micro PDF417	R
Micro QR	X
Code One	X
USPS Postnet	P
USPS Intelligent Mail	M
Royal Mail	x
USPS Planet	L
KIX Post	K
Australian Postal	A
Japan Post	J
Passport OCR	O

Symbology ID Number

Symbology	ID Number
Code 128	002
GS1-128 (UCC/EAN-128)	003
EAN-8	004
EAN-13	005
UPC-E	006
UPC-A	007
Interleaved 2 of 5, Febraban	008
ITF-14	009
ITF-6	010
Matrix 2 of 5	011
Code 39	013
Codabar	015
Code 93	017
China Post 25	019
AIM 128	020
ISBT 128	021
ISSN	023
ISBN	024
Industrial 25	025
Standard 25	026
Plessey	027
Code11	028
MSI-Plessey	029
GS1 Composite	030
GS1 Databar (RSS)	031
PDF417	032
QR Code	033
Aztec	034
Data Matrix	035
Maxicode	036
Chinese Sensible Code	039
GM Code	040

Symbology	ID Number
Micro PDF417	042
Micro QR	043
Passport OCR	066
USPS Postnet	096
USPS Intelligent Mail	097
Royal Mail	098
USPS Planet	099
KIX Post	100
Australian Postal	101
Japan Post	102

ASCII Table

Hex	Dec	Char
00	0	NUL (Null char.)
01	1	SOH (Start of Header)
02	2	STX (Start of Text)
03	3	ETX (End of Text)
04	4	EOT (End of Transmission)
05	5	ENQ (Enquiry)
06	6	ACK (Acknowledgment)
07	7	BEL (Bell)
08	8	BS (Backspace)
09	9	HT (Horizontal Tab)
0a	10	LF (Line Feed)
0b	11	VT (Vertical Tab)
0c	12	FF (Form Feed)
0d	13	CR (Carriage Return)
0e	14	SO (Shift Out)
0f	15	SI (Shift In)
10	16	DLE (Data Link Escape)
11	17	DC1 (XON) (Device Control 1)
12	18	DC2 (Device Control 2)
13	19	DC3 (XOFF) (Device Control 3)
14	20	DC4 (Device Control 4)
15	21	NAK (Negative Acknowledgment)
16	22	SYN (Synchronous Idle)
17	23	ETB (End of Trans. Block)
18	24	CAN (Cancel)
19	25	EM (End of Medium)
1a	26	SUB (Substitute)
1b	27	ESC (Escape)
1c	28	FS (File Separator)
1d	29	GS (Group Separator)

Hex	Dec	Char
1e	30	RS (Request to Send)
1f	31	US (Unit Separator)
20	32	SP (Space)
21	33	! (Exclamation Mark)
22	34	" (Double Quote)
23	35	# (Number Sign)
24	36	\$ (Dollar Sign)
25	37	% (Percent)
26	38	& (Ampersand)
27	39	` (Single Quote)
28	40	((Left/ Opening Parenthesis)
29	41) (Right/ Closing Parenthesis)
2a	42	* (Asterisk)
2b	43	+ (Plus)
2c	44	, (Comma)
2d	45	- (Minus/ Dash)
2e	46	. (Dot)
2f	47	/ (Forward Slash)
30	48	0
31	49	1
32	50	2
33	51	3
34	52	4
35	53	5
36	54	6
37	55	7
38	56	8
39	57	9
3a	58	: (Colon)
3b	59	; (Semi-colon)
3c	60	< (Less Than)
3d	61	= (Equal Sign)

Hex	Dec	Char
3e	62	> (Greater Than)
3f	63	? (Question Mark)
40	64	@ (AT Symbol)
41	65	A
42	66	B
43	67	C
44	68	D
45	69	E
46	70	F
47	71	G
48	72	H
49	73	I
4a	74	J
4b	75	K
4c	76	L
4d	77	M
4e	78	N
4f	79	O
50	80	P
51	81	Q
52	82	R
53	83	S
54	84	T
55	85	U
56	86	V
57	87	W
58	88	X
59	89	Y
5a	90	Z
5b	91	[(Left/ Opening Bracket)
5c	92	\ (Back Slash)
5d	93] (Right/ Closing Bracket)

Unicode Key Maps

6E	70	71	72	73	74	75	76	77	78	79	7A	7B	7C	7D	7E	•	•	•		
01	02	03	04	05	06	07	08	09	0A	0B	0C	0D	0F	4B	50	55	5A	5F	64	69
10	11	12	13	14	15	16	17	18	19	1A	1B	1C	1D	4C	51	56	5B	60	65	6A
1E	1F	20	21	22	23	24	25	26	27	28	29	2B				5C	61	66		
2C	2E	2F	30	31	32	33	34	35	36	37	39			53			5D	62	67	6C
3A	3B	3C	3D				3E	3F	38	40	4F	54	59	63	68					

104 Key U.S. Style Keyboard

6E	70	71	72	73	74	75	76	77	78	79	7A	7B	7C	7D	7E	•	•	•		
01	02	03	04	05	06	07	08	09	0A	0B	0C	0D	0F	4B	50	55	5A	5F	64	69
10	11	12	13	14	15	16	17	18	19	1A	1B	1C	2B	4C	51	56	5B	60	65	6A
1E	1F	20	21	22	23	24	25	26	27	28	29	1D				5C	61	66		
2C	2D	2E	2F	30	31	32	33	34	35	36	37	39		53			5D	62	67	6C
3A	3B	3C	3D				3E	3F	38	40	4F	54	59	63	68					

105 Key European Style Keyboard

SCANNING MADE SIMPLE

Newland EMEA
+31 (0) 345 87 00 33
info@newland-id.com

Rolweg 25
4104 AV Culemborg
The Netherlands



@NewlandEMEA